

This camera manual library is for reference and historical purposes, all rights reserved.

This page is copyright by mike@butkus.org M. Butkus, N.J.

**This page may not be sold or distributed without the expressed
permission of the producer**

I have no connection with any camera company

If you find this manual useful, how about a donation of \$3 to: M. Butkus, 29 Lake Ave., High Bridge, NJ 08829-1701 and send your E-mail address too so I can thank you. Most other places would charge you \$7.50 for a electronic copy or \$18.00 for a hard to read Xerox copy. These donations allow me to continue to buy new manuals and maintain these pages. It'll make you feel better, won't it?

If you use Pay Pal, use the link below. Use the above address for a check, M.O. or cash. Use the E-mail of butkusmi@ptd.net for PayPal.



[back to my "Orphancameras" manuals /flash and light meter site](#)

Only one "donation" needed per manual, not per multiple section of a manual !

The large manuals are split only for easy download size.



Rolleicord
IV

I N P R A C T I C A L U S E

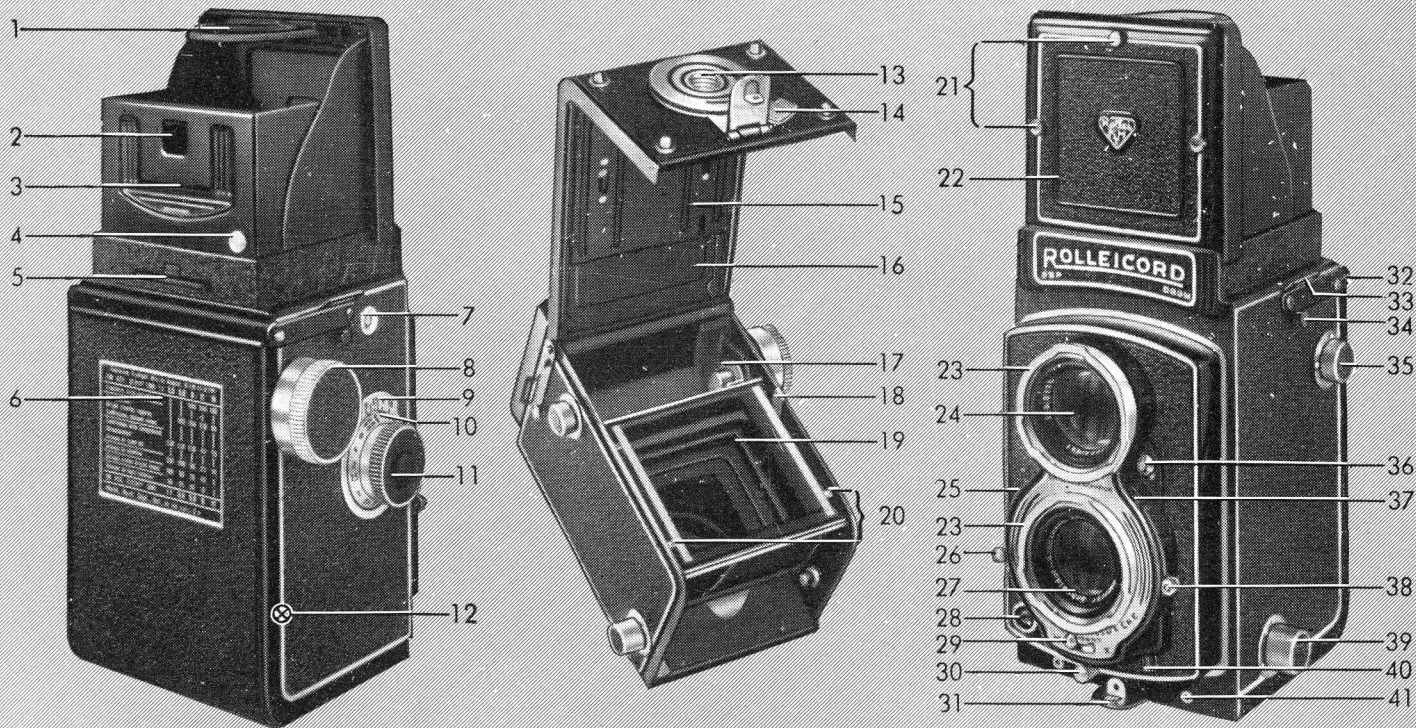

1 Focusing magnifier
2 Rear sight for direct view finder

3 Focusing hood
4 Release button for direct view finder flap

5 Retaining device for Rolleikin ground glass mask

6 Exposure table
7 Exposure counter window

- | | |
|---|---|
| 8 Film winding knob | 24 Viewing lens |
| 9 Depth of field scale | 25 Indicator window for shutter speeds |
| 10 Focusing scale | 26 Shutter speed control lever |
| 11 Focusing knob | 27 Taking lens |
| 12 Focal or film plane (focusing distances measured from this line) | 28 Flash cable socket |
| 13 Tripod socket | 29 Synchro M-X lever |
| 14 Back locking lever | 30 Shutter tensioning and release lever |
| 15 Adjustable film pressure plate | 31 Back lock clip |
| 16 Combination back for 120 (B 11 8) and 35 mm. film | 32 Spring hinge for back |
| 17 Winding key of take-up spool | 33 Eyelet slot for neck strap |
| 18 Sliding lever for engaging counter | 34 Strap hook |
| 19 Anti-reflection baffles | 35 Take-up spool knob |
| 20 Indicator marks for starting No. 120 roll film | 36 Release knob for double exposure prevention lock |
| 21 Pin-socket for Rolleikin direct view finder mask | 37 Indicator window for diaphragm openings |
| 22 Direct view finder flap | 38 Diaphragm control lever |
| 23 Double bayonet mount for lens accessories and lens hood | 39 Film spool knob (and Rolleikin-rewind knob) |
| | 40 Cable release socket |
| | 41 Locating sockets for Panorama Head |

*P*recise construction of the camera, fool-proof operation, all controls easily manipulated in picture-taking position: These are the features which, together, make up the convenient operating method of the Rollei.

The Rolleicord IV is equipped with the high quality Schneider Xenar f:3.5 lens and many features of important technical advantage. The fine photographic performance of this camera is made fully available through its extremely simple operation.

The following pages will fully describe the principle as well as the correct methods of handling the camera. Many rules and hints are included, making it possible for even the inexperienced to acquire soon proficiency in the practice of Rollei photography.

We trust that this booklet will be a helpful and constant guide to the new Rolleicord owner, speeding him on his way to real success with the camera.

FRANKE & HEIDECHE
BRAUNSCHWEIG

THE QUICK BASIC PRINCIPLE

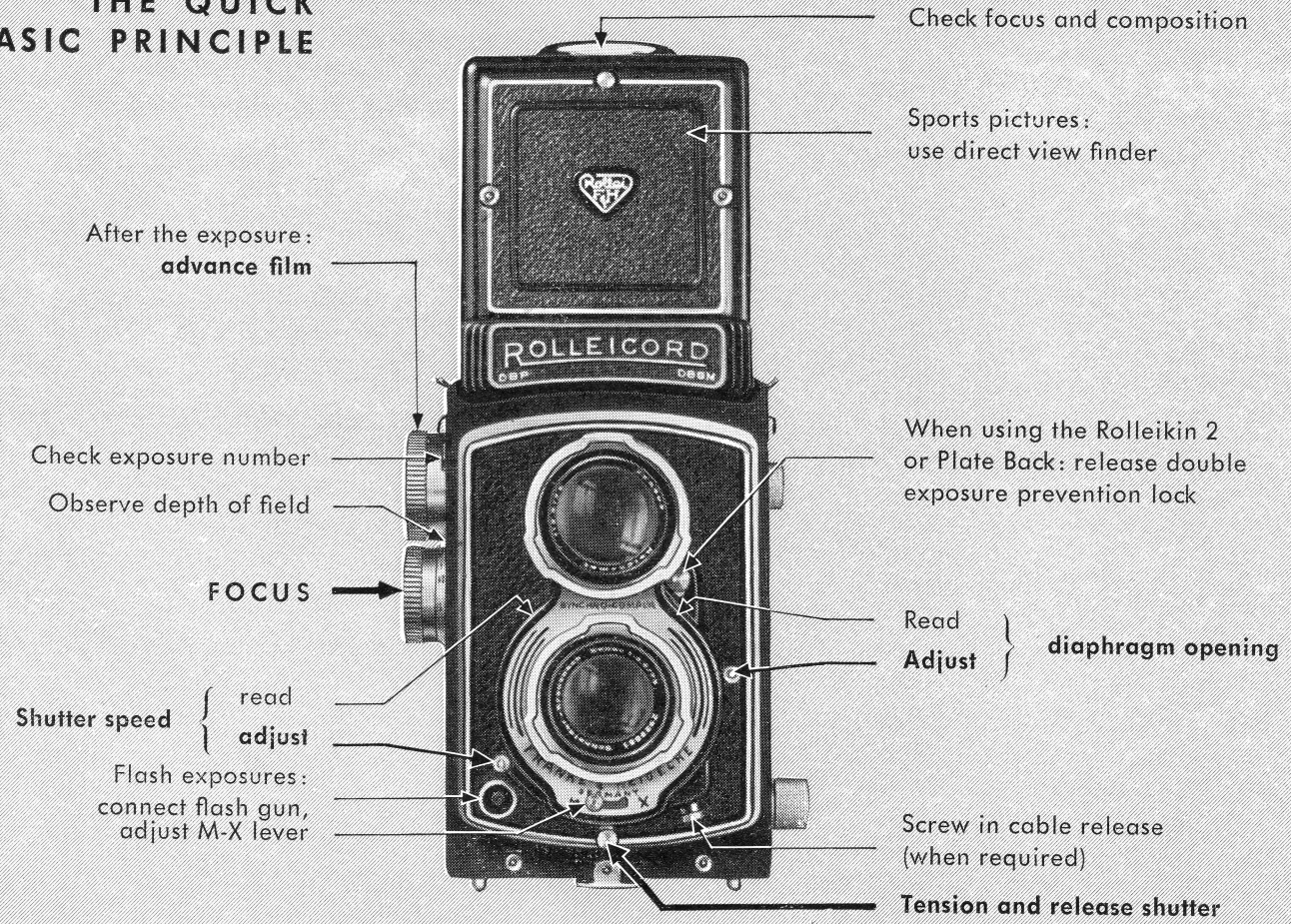

REFERENCE INDEX:

Page:

6 **I. A Brief Rolleicord-
Anatomy**12 **II. Rolleicord in Operation**

12 Ever Ready Case

12 Lens Cap

14 Holding the Camera

16 Focusing Hood

16 Focusing Magnifier

17 Direct View Finder

18 Focusing

18 Diaphragm

19 Depth of Field

24 Shutter and Release

26 Exposure

28 Auxiliary Focusing Knob

29 **III. Flashlight Technique**

32 Flashlight Tips

Page:

34 **IV. Loading and Film
Transport**

34 Back

36 Inserting Film Spool

38 Starting of Film

39 Film Transport

40 **V. Tips on Picture-Taking**

40 Landscapes

42 Portraits

43 Children

43 Animals

44 Snapshots

45 Sports

46 Theater and Music Hall

46 Night Photography

47 Copying

48 Reflecting Surfaces

Page:

49 Plants

49 Color Pictures

50 Panoramas

50 Rolleigrid Lens

52 Micro Photography

53 Care of Camera

53 In Case of Damage to the
Camera**Tables:**

21 Depth of Field

23 Speed of Moving Objects and
Shutter Speed

28 Speed of Emulsions

30 Flash-Contact
and Shutter Speed

51 Practical Accessories

54 Rollei Filters

55 Rolleinars

This Rolleicord instruction book offers you the basic information necessary for the use of the camera. Practical matters of technique are adequately discussed, usually in the form of concise tips covering the most important phases of picture taking. Easy to use, highly informative tables are also included. It will therefore remain a source of information of permanent value to you.

Important: Before attempting to use or handle the camera we urge you to carefully read pages 12, 16, 24 and 34.

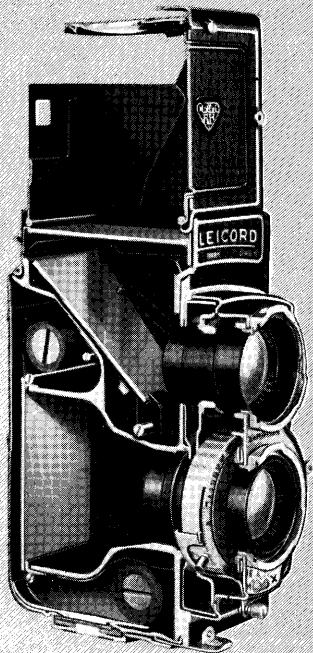

I. A BRIEF ROLLEICORD-ANATOMY

The Rolleicord owes its photographic efficiency to the classic Rollei design: the twin-lens reflex-principle.

It adopted this basic idea from the several years older model, the Rolleiflex. To achieve the highest possible performance in its price field, the Rolleicord went its own way in the matter of mechanical development. This resulted in certain differences between the two cameras. In spite of these variations numerous common advantages exist in operation and practical use, so that working rules conform in many respects.

The quick, sure and easy handling of the Rolleicord is inherent in the design and construction of the camera.

Construction of the Twin Lens Reflex

In the Rolleicord two separate cameras are joined in a twin-camera with a common sturdy die-cast body: the bottom half is the

taking-camera, in which the film is exposed, and the upper half is the

viewing-camera, which is designed on the mirror-reflex principle. Its special task is to make the focusing visible on the ground glass and to supply a control image essentially similar to that of the prospective picture.

The image forming rays are transmitted by the fully open viewing lens, projected on to the ground glass screen via the mirror and the result is a right-side-up, but laterally reversed ground glass image, in the full size of the original picture. This viewing image is visible at all times and every detail of composition and framing may be watched even during exposure.

The ground glass screen is ruled vertically and horizontally across the center making it possible to detect errors, such as lines which converge that should be parallel or a slanting horizon, in time to notice and correct them. It is easy to straighten or level the camera by means of the lines on the ground glass screen.

Above all, the ground glass screen provides the means for **focusing the camera**. This is accomplished by rotating the focusing knob. Both lenses, which are inflexibly coupled to each other by means of a sturdy common front plate, are thereby adjusted simultane-

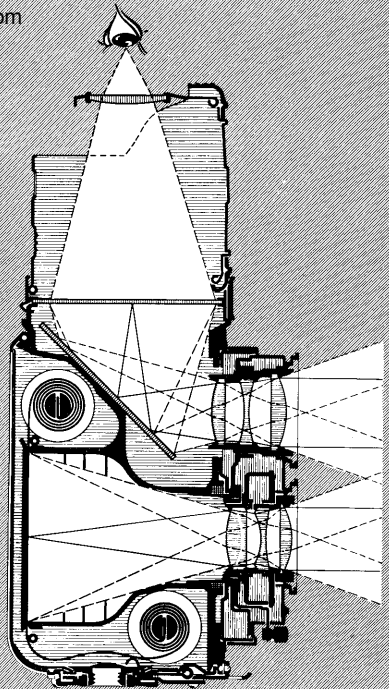

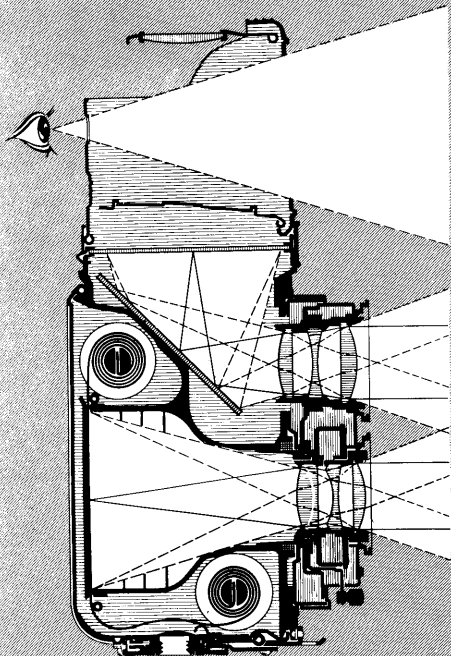

ously: a sharp viewing image, therefore, guarantees an equally sharp picture. Since the Rolleicord is equipped with a fast viewing lens and an optically prepared ground glass screen, the viewing image is extremely bright and clear and focusing can be done very critically.

The **focusing hood**, which is designed for one-hand operation, is kept in both open and closed positions by spring tension. It is equipped with a **magnifier** offering approximately 2.5 times magnification for critical focusing.

After focusing the camera, the front flap of the focusing hood may be folded back: the focusing hood is thereby converted to an open frame type **view finder**, through which it is possible to view the subject in natural size and to follow action easily.

Focusing the front lens panel throughout the range from ∞ (infinity) - 35 $\frac{1}{2}$ inches (distances measured from the focal or film plane to the subject) is accomplished by one full turn of the focusing knob. The special design of the focusing mechanism (a cam-drive based on the principle of the archimedic spiral) insures uniform movement of the lens panel in both directions without play or backlash.

Tied in with the movement of the lenses is a simple sliding mechanism, located beneath the ground glass,

providing completely automatic **parallax compensation**. Consequently, the final picture is always framed exactly as originally viewed on the ground glass screen. Similarly complete control can be had even when using supplementary Rolleinar lenses for close-up work merely by adding the Rolleipar.

Diaphragm openings and **shutter speeds** are set by means of control levers on both sides of the taking lens and are observed through two separate indicator windows. The selected values are read from above.

The **Synchro-Compur shutter** has a single tensioning and release lever with double exposure prevention. The shutter can therefore be tensioned and immediately afterwards released without changing position of the hands. Thus all diaphragm and shutter manipulations are accomplished with the camera in operating position.

Since the two **lenses** are of identical focal length ($f = 75$ mm.) it follows that the images in both sections of the camera will always be critically focused on the same portion of the subject simultaneously. The Schneider Xenar $f:3.5$ taking lens, is a four glass construction with two cemented elements (modified Taylor-type) and features outstanding correction for black and white and color pictures, while the three-element viewing-lens $f:3.2$ meets with the special requirements for best

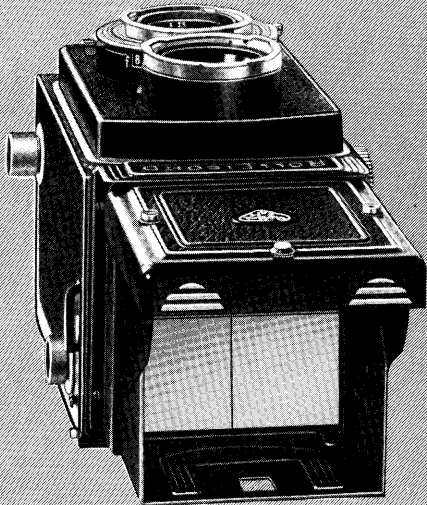

ground glass focusing. Both lenses are treated with abrasion resistant coating. The bayonet receptacles circling the mounts are intended for attaching the lens hood and supplementary optical accessories, which in this way will be held in optically correct position and form a solid unit with the camera.

The removable **combination back** is attached to the camera by means of hinges fitted with locking clips, and at the bottom it contains the tripod socket and the safety back lock. Its adaptability for the two picture sizes $2\frac{1}{4} \times 2\frac{1}{4}$ " , and 24×36 mm. is the result of the adjustable film pressure plate which can be set for No. 120 (B II 8)-film (with paper backing), or for 35 mm. film (without paper backing) when used in conjunction with the Rolleikin 2 attachment. In both cases a film channel is created with a width that corresponds to the thickness of the film being used. Thus the film can be properly held in the focal plane, and also can slide through without undue friction when advanced.

Film Transport and Double Exposure Prevention

The film transport mechanism (for roll film) is equipped with a **double exposure prevention device**. Shutter and film transport are thus locked alternately so that the correct order of the operating steps necessarily has to be: advance film, tension shutter, release shutter.

Turning the film winding knob until it stops (film lock) will advance the film one full frame and at the same time cause the next number to appear in the exposure counter window. Now the shutter can be tensioned. After release, the operation of the inter-lock is reversed so that the shutter is locked until the film has been properly advanced to the next frame. In this way double exposures or blanks are neatly avoided.

In special cases – when using the Rolleikin 2 or Plate Back – the double exposure prevention lock must be released or else the shutter would be permanently

locked. If engaged after the exposure, the lock will furthermore serve as an effective shutter release guard.

-- Intentional double or multiple exposures (trick shots) on roll film are also possible through temporary release of the lock.

Proper starting of the film when loading the camera is easily accomplished. Immediately after inserting the film it is advanced as far as the arrow mark on the paper backing. Closing the back at this point depresses the sliding lever and engages the film measuring mechanism. The knob can now be turned only the correct amount to the stop. The number in the film counter window will automatically advance from 0 to 1, when the film is ready for the first exposure.

The last sign visible in the exposure counter window (after No. 12) is a center-dotted \odot to indicate that all the film has been exposed. Opening the back will cause the counter dial to return to No. 0.

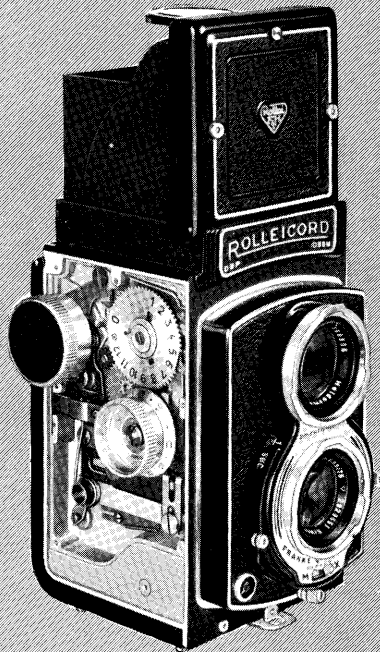

II. THE ROLLEICORD IN OPERATION

The Ever Ready Case

deserves mention here since it is so often used with the camera.

The case may also be used with the Rolleikin 2 attachment merely by removing the leather insert to permit passage of the larger-counter knob. In order to assure solid contact when working with a tripod, do not use the ever ready case.

To Open: lift the top by grasping the snap catch buttons at the rear and fold forward and down (1).

To Close: pull the top over the camera and push down to engage the snaps. (Simultaneous folding of the focusing hood is also possible with this movement.) Always return focusing knob to infinity position since the extended front may otherwise interfere with closing the case.

Removal of Camera from Case: pull up the clips on the side walls of the case (2), spread the case apart, lift the camera forward and out (3).

Inserting Camera into the Case: pull up the side clips, spread the case apart and lower the camera backwards into the case. Push the clips through the strap holders of the camera.

For Cameras with Rolleikin 2: straighten out the five metal tabs, which hold the leather insert on the inside of the case, with a knife (4) and then push out the now superfluous disc (5).

The Lens Cap

The lens cap of light-metal serves to protect the lenses when not using the camera for any length of time or when traveling. It is attached to the bayonet ring of the taking lens by means of a locking knob. The cap fits in front of the lenses only when the upper part which is marked Rollei covers the viewing lens.

To Remove Lens Cap: slide the locking knob in the middle of the cap upwards (6).

Attaching Lens Cap: slide locking knob upwards, place cap over the mounts, slide knob downwards.

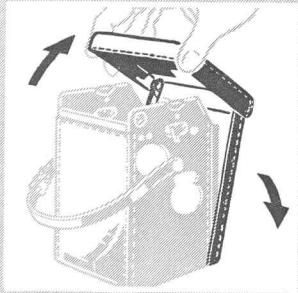

1

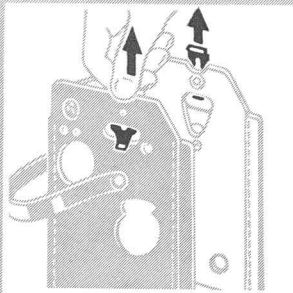

2

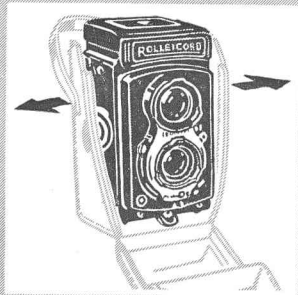

3

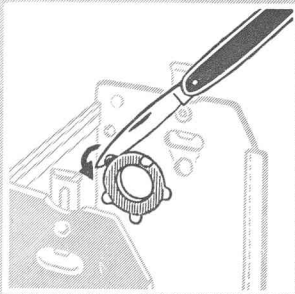

4

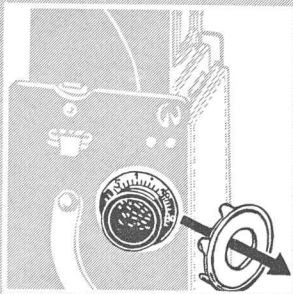

5

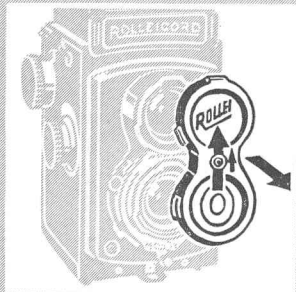

6

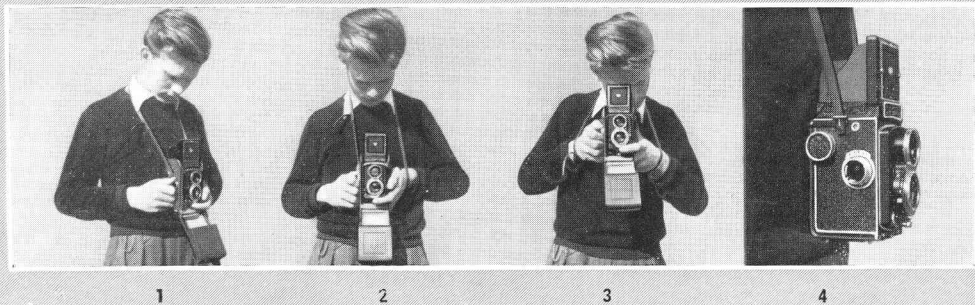

Holding the Camera

Basic rule: camera hanging around the neck with taut strap and held firmly with both hands. The left hand grasps the camera at the bottom, index finger on the combined shutter tensioning and release lever. The right hand takes over the focusing (1).

In this position shutter and diaphragm are easily controlled with two fingers.

The carrying strap is adjusted to a comfortable length, so that the camera may be carried on the shoulder when not in use. In order that the shutter may be released with taut strap to avoid camera movement, loop the strap around the left hand, thus shortening it to achieve normal viewing distance (2). Further shortening of the strap when using the magnifier can easily be effected by making use of the right hand in the same way (3).

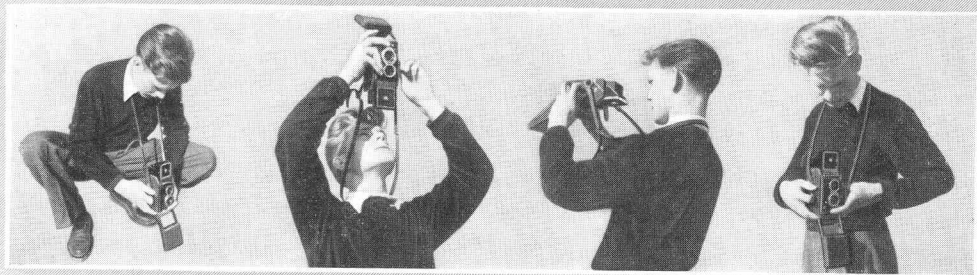

5

6

7

8

Caution: a wrong or uncomfortable "grip" may cause you to inadvertently lift the hanging top of the ever ready case.

A **leather neck strap** is also available for working without the ever ready case. To attach: slip both ends through the strap holder slots and fasten to the strap hooks (4).

Waist-level or eye-level positions for the camera are considered normal for most pictures. The extremely flexible Rollei, however, readily permits exposures at or near floor level, overhead, shooting straight up or down, and occasionally, surprise snaps "around the corner". The illustrations (5-8) show a few possibilities for such pictures with the camera in different positions.

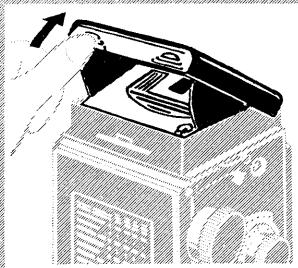

1

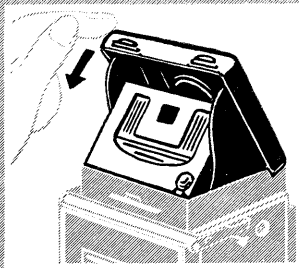

2

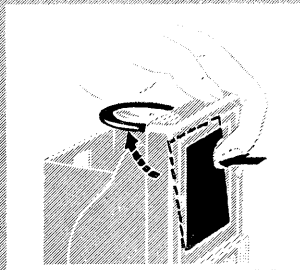

3

Focusing Hood

To open: lift the rear edge of the focusing hood cover – spring tension keeps it open (1).

To close: fold down focusing hood (2).

The focusing hood can also be folded down with the same hand movement that closes the ever ready case (see page 12).

The push-button at the rear of the focusing hood serves to hold the Rolleikin ground glass screen mask or the Rolleigrd lens.

Focusing Magnifier

To raise: push the direct view finder flap inwards – the magnifier springs into position (3).

To lower (before closing focusing hood): fold down magnifier (4).

Use of magnifier: use magnifier as close to the eye as possible.

The magnifier is interchangeable and may be replaced for the convenience of near or far sighted people. Strengths from minus 3 to plus 3 diopters are available.

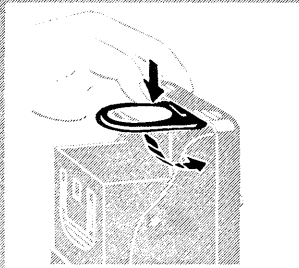

4

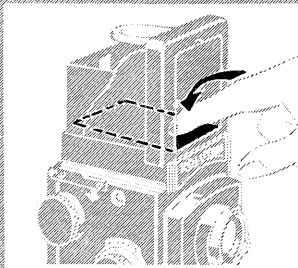

5

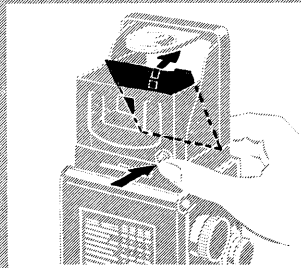

6

Direct View Finder

To open: push the direct view finder flap inwards until it locks into place (5).

To Close: release the flap by means of the button on the back of the focusing hood – it will spring back into place (6).

The two pin-sockets and small knob on the front of the hood permit attachment of the Rolleikin direct view finder mask.

Changing Magnifier (if eye-sight demands)

To remove: take hold of magnifier by both surfaces, push it against the retaining spring (in direction of the hinge of the magnifier holder) and then fold it up and lift out.

To insert: place in socket and push back against spring until it can be snapped down into place.

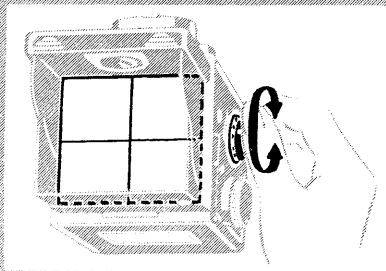

Focusing

Focus the Rolleicord by turning the focusing knob, at the same time critically observing the sharpness of the ground glass screen image. The footage scale serves also to indicate the depth of field, a matter which need not concern you too much at first.

The magnifier facilitates the most critical focusing. Important:

Focus so that the greatest degree of sharpness prevails at main subject distance

The Diaphragm



The diaphragm controls the amount of light passing through the lens. It has a double effect:

Stopping down

increases the depth of field and
reduces the effective amount of light

Therefore, the exposure must be increased correspondingly at smaller diaphragm openings. The following table gives the ratio of exposure at the different openings:

Diaphragm	3.5	4	5.6	8	11	16	22
Exposure	$\frac{3}{4}$	1	2	4	8	16	32

Notice that each succeeding smaller stop requires exactly double the exposure of the preceding one. Only exception – the relation between f:3.5 and f:4.

The diaphragm scale itself is easily seen in the peep window to the left of the lens. The dot before f:22 indicates the position for f:16.

Setting of Diaphragm: by means of the diaphragm lever.

Depth of Field

Most picture subjects require that acceptable sharpness extend somewhat before and behind the exact distance focused on. Landscapes, for instance, require considerable "depth of field". Two factors influence the extent of the sharp zone: distance actually focused on and diaphragm opening.

In contrast to close-up focusing the sharp zone is many times greater when the lens is focused on long distance:

1. The depth of field increases with the taking distance

In any case, however, the sharp zone of the picture may be increased considerably by stopping down the diaphragm:

2. The depth of field increases when stopping down

As a practical rule the second alternative is preferable and only in emergency cases should the taking distance be increased because of loss in image size.

The extent of the depth of field at any distance may be read off on the focusing knob.

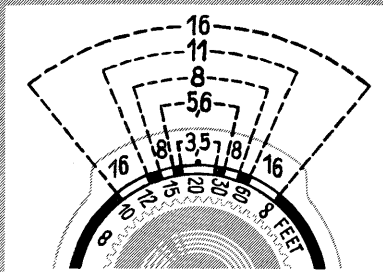

Depth of Field Scale

On and next to the focusing knob two scales are visible: the movable focusing scale with figures indicating feet and the fixed depth of field scale with the diaphragm values. The diaphragm figures are arranged in pairs symmetrically on both sides of the central focusing point; the diaphragm opening f:5.6 and f:11 are represented by black sections below the scale.

The center of each footage figure indicates the correct setting for that distance.

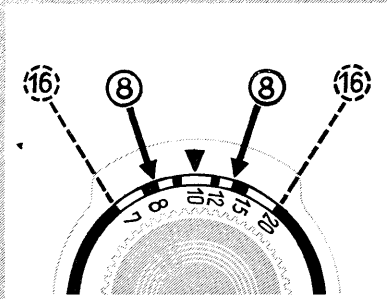

1

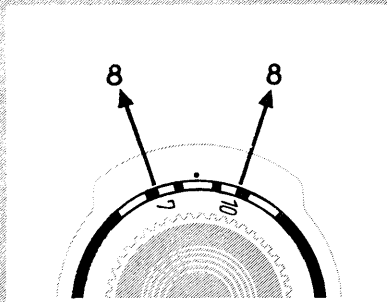

2

In Practice

After focusing, the near and far limits of the depth of field may be read off directly below the pair of figures indicating the diaphragm opening chosen.

The section of the footage scale bracketed between the identical figures representing the diaphragm opening indicates the exact zone of sharp focus.

1. Example: focusing to 10 ft with diaphragm opening 8 gives a depth field 8 ft to 13 ft, focusing to 10 ft with diaphragm opening f:16 gives on the other hand a depth of field from 7 ft to 20 ft. (Stopping down improves the depth of field.)

Considerable stopping down necessitates greatly increased exposure time. To obtain depth of field with the largest possible diaphragm opening, a different method of focusing must be employed:

2. Example: the subject requires sharpness from 7 ft to 10ft. (Other distances, if unknown, can be read directly off the scale after focusing separately to the limits required.) Procedure: the focusing knob is turned until both footage values are located opposite identical diaphragm openings, and in this way the most favourable diaphragm opening is obtained, in this case f:8.

Depth of Field Table (distances in feet)

Diaphragm		4	5.6	8	11	16	22	
Taking distance (in feet)	∞	141' - ∞	86' - ∞	61' - ∞	43' - ∞	31'4" - ∞	21'6" - ∞	15'7" - ∞
	60'	42' - 105'	35' - 198'	30'3" - ∞	25' - ∞	20'7" - ∞	15'10" - ∞	12'4" - ∞
	30'	24'9" - 38'	22'3" - 46'	20'2" - 59'	17'8" - 99'	15'4" - ∞	12'6" - ∞	10'3" - ∞
	20'	17'6" - 23'4"	16'3" - 26'	15'1" - 29'8"	13'8" - 37'	12'2" - 55'	10'4" - 290'	8'9" - ∞
	15'	13'7" - 16'10"	12'9" - 18'2"	12'1" - 19'10"	11'2" - 23'	10' - 29'8"	8'10" - 50'	7'8" - 350'
	12'	11'1" - 13'2"	10'6" - 13'11"	10' - 14'8"	9'5" - 16'8"	8'8" - 19'6"	7'8" - 27'1"	6'10" - 52'
	10'	9'4" - 10'10"	9' - 11'5"	8'7" - 12'1"	8'2" - 13'2"	7'7" - 14'10"	6'10" - 19'	6'1" - 27'5"
	8'	7'7" - 8'6"	7'5" - 8'10"	7'2" - 9'2"	6'10" - 9'9"	6'6" - 10'7"	6' - 12'5"	5'5" - 15'8"
	7'	6'8" - 7'4"	6'6" - 7'7"	6'5" - 7'10"	6'1" - 8'3"	5'9" - 8'10"	5'5" - 10'1"	4'12" - 12'1"
	6'	5'9" - 6'3"	5'8" - 6'5"	5'6" - 6'7"	5'4" - 6'11"	5'2" - 7'4"	4'9 $\frac{1}{2}$ " - 8'1"	4'5 $\frac{1}{2}$ " - 9'4"
	5'	4'10 $\frac{1}{8}$ " - 5'2"	4'9" - 5'3"	4'7 $\frac{3}{8}$ " - 5'5"	4'6 $\frac{3}{8}$ " - 5'7"	4'4 $\frac{1}{2}$ " - 5'10"	4'1 $\frac{5}{8}$ " - 6'4"	3'10 $\frac{3}{4}$ " - 7'1"
	4'	3'10 $\frac{3}{4}$ " - 4'1 $\frac{1}{4}$ "	3'10 $\frac{1}{8}$ " - 4'2"	3'9 $\frac{3}{8}$ " - 4'2 $\frac{7}{8}$ "	3'8 $\frac{3}{8}$ " - 4'4 $\frac{1}{4}$ "	3'7 $\frac{1}{4}$ " - 4'6"	3'5 $\frac{3}{8}$ " - 4'9 $\frac{3}{8}$ "	3'3 $\frac{3}{8}$ " - 5'2"
3.5'	3'5 $\frac{1}{8}$ " - 3'6 $\frac{7}{8}$ "	3'4 $\frac{5}{8}$ " - 3'7 $\frac{1}{2}$ "	3'4" - 3'8 $\frac{1}{8}$ "	3'3 $\frac{1}{4}$ " - 3'9 $\frac{1}{8}$ "	3'2 $\frac{3}{8}$ " - 3'10 $\frac{1}{2}$ "	3'1" - 4'2 $\frac{1}{8}$ "	2'11 $\frac{3}{8}$ " - 4'4 $\frac{1}{8}$ "	
3'	2'11 $\frac{3}{8}$ " - 3'5 $\frac{5}{8}$ "	2'11" - 3'1"	2'10 $\frac{1}{2}$ " - 3'1 $\frac{1}{2}$ "	2'10" - 3'2 $\frac{1}{4}$ "	2'9 $\frac{3}{8}$ " - 3'3 $\frac{1}{8}$ "	2'8 $\frac{1}{4}$ " - 3'4 $\frac{3}{4}$ "	2'7 $\frac{1}{8}$ " - 3'6 $\frac{7}{8}$ "	
Diaphragm	3.5	5.6	8	11	16	22		

Since the sharp zone in the picture does not end abruptly, but gradually changes to something less sharp, it is generally sufficient to read the depth of field in round figures. With this in mind the scale on the focusing knob has been calibrated for quick and practical use.

If exact figures are desired, these may be found in the table on page 21.

The Depth of Field Table

For normal use the upper of the double row of diaphragm figures is used as in the case when an enlargement is to be made later from the entire $2\frac{1}{4} \times 2\frac{1}{4}$ negative. (These diaphragm openings are based on a circle of confusion of $1/1400$ of the focal length.)

On the other hand if enlargements are to be made from a small portion of the negative (or Rollei-kin negatives), it is advisable to go by the lower row of diaphragm openings (circle of confusion = $f/2000$).

Explanation: the degree of sharpness required from a negative is exclusively dependent on the magnification of the prospective enlargement and its subsequent viewing distance.

In order to obtain a correct perspective impression at 10" (a comfortable viewing distance) a whole Rollei negative would have to be enlarged $3.3 \times$ to $7\frac{1}{2} \times 7\frac{1}{2}$ ". Enlargements of this size, viewed at 10", determine the basis for the minimum acceptable sharpness. With this in mind the size of the circle of confusion is computed and the limits of the depth of field ascertained. Negatives made in this way will permit enlargements also to larger sizes, while still retaining the same impression of sharpness. This is because the viewing distance is always correspondingly increased.

With enlargements from portions of Rollei negatives or from Rollei-kin negatives, the requirements with regard to sharpness are more critical. In this case depth of field is calculated using a smaller circle of confusion. In practical use the required depth is obtained through the use of a smaller diaphragm opening. The effectiveness of the scale on the camera itself may be extended in the same manner merely by using the next smaller diaphragm opening than the one indicated for the desired zone.

If enlargements of very great size are to be made, use a diaphragm opening two stops smaller than the one indicated.

Speed of Moving Subjects and Shutter Speeds

		Miles per hour approximately															
		3 mph		6 mph		12 mph		30 mph		60 mph		120 mph					
Example:		Pedestrians		Runners Moving air		Bicycles Windy		Light Athletics Stormy Surf		Automobiles Railway Trains Racing		Motor Racing					
Distance (yards)	40		1/25	1/50	1/25	1/50	1/100	1/50	1/100	1/250	1/100	1/250	1/500	1/250	1/500	1/500	50
	15	1/25	1/50	1/100	1/50	1/100	1/250	1/100	1/250	1/500	1/250	1/500	1/500	1/500			25
	8	1/50	1/100	1/250	1/100	1/250	1/500	1/250	1/500	1/500	1/500						12
	4	1/100	1/250	1/500	1/250	1/500	1/500	1/500									6

Moving Objects require short shutter speeds in order to be reproduced sharply. For this purpose the table contains accurately computed minimum values, depending on the factors: speed, distance and direction.

Taking distance: the yard column on the left stands for sufficient sharpness ($f/1400$), the yard column on the right for increased sharpness ($f/2000$). In spite of

these normally correct figures, it is often possible in actual photography to use longer shutter speeds. This is because the eye interprets slight unsharpness as giving an added impression of speed.

Long arrow = direction of movement.

A short arrow = taking direction (\rightarrow up to 10° , \nearrow up to 30° and \uparrow up to 90° to the direction of movement).

Time Exposure	Tripod Pictures:				Hand-Held Pictures:				
	Slow Speeds				Fast Speeds				
B	1	1/2	1/5	1/10	1/25	1/50	1/100	1/250	1/500 sec.

Shutter and Shutter Release

The single lever Synchro-Compur shutter is a between-the-lens shutter with combined lever for tensioning and releasing, employing the above mentioned speeds. 1/50th sec. stands as the most commonly used instantaneous shutter speed with little risk of camera movement. Shutter speeds longer than 1/25th sec. are in general possible only with a tripod.

The shutter speed values appear in the indicator window to the right above the taking lens. Intermediate speeds may be set at any point between 1 sec. and 1/10th sec. and between 1/25th and 1/250th sec. – When setting to 1/500th sec. a supplementary spring in the shutter is tensioned, noticeable by added resistance. The shutter must be set to or changed from higher speed before tensioning!

1/500th sec. – set speed first, – then cock shutter!

In the selection of shutter speed the movement in the picture must be considered, in order to avoid unsharpness due to movement (see table on page 23).

A cable release can be screwed into the cable release socket. It should be used to release the shutter when long time exposures are made on a tripod in order to avoid camera movement.

The camera may be attached to a **tripod** by means of the threaded socket on the bottom. **Caution:** the length of the tripod screw must not exceed 3/16". If longer, employ a washer or spacer to avoid damage to camera. For cameras with continental tripod sockets a reducing bushing is available.

The double exposure prevention lock is connected when the knob is in the upper position (**1a**) and is disconnected when in the lower position (**1b**). When disconnected (**1b**) a red tell-tale mark becomes visible next to the coupling knob: this is a warning signal indicating "double exposure possible".

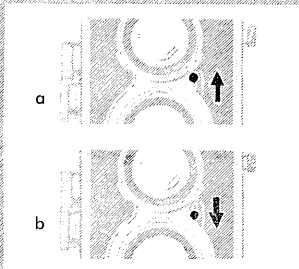

1

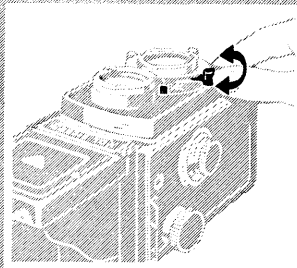

2

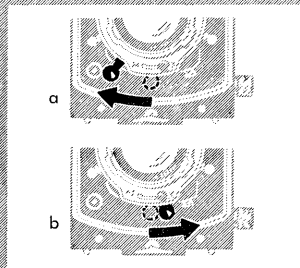

3

Engage the lock when using roll film.

Disengage (see page 10) when employing Rolleikin 2, Plate Adapter Back or when making **intentional** double exposures.

Reengage the lock after finishing a double or multiple exposure: **b e f o r e** re-tensioning shutter!

Setting the Shutter Speeds: by means of shutter speed lever (2).

Tensioning: move tension and release lever to the right as far as it will go (3a).

Releasing Shutter: gently move tension and release lever to the left until click of shutter is heard (3b).

Time Exposures

Set shutter speed control to B: move tension and release lever to the left as far as stop and hold for required time. To avoid camera movement, use the cable release! Very long time exposures are easily made with a locking type cable release.



1 : 22 . 90 sec.

Great Depth of Field required
(= small diaphragm opening)

Correct exposure is had by properly extending exposure time.

The Exposure

The correct exposure is dependent upon existing illumination (more exactly: subject brightness) and results from the selection of the proper diaphragm opening and shutter speed. Consequently the following relationship exists:

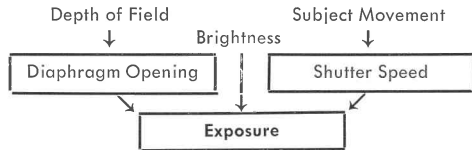

With the Rolleicord, various settings of diaphragm openings and speeds may be combined as required for normal picture-taking. Only under unfavorable shooting conditions are these possibilities limited, so that a compromise solution is sometimes necessary. Nevertheless the following must be kept in mind: underexposure results in hopelessly lost shadow detail, whereas overexposure may be compensated for to a great extent by proper processing.

A golden rule for safe exposure:

Always expose for the **shadows**,
rather a bit **more** than too little!

The Exposure Table

The table on the back of the camera is based on the speeds of the two most commonly used types of film: the upper scale is used with films rated at 100 ASA (21/10° DIN), and the lower scale is used with film rated at 50 ASA (18/10° DIN). Conversion of the table for use with other film speeds is possible, if it is remembered that half the ASA rating (or minus 3/10° DIN) means that double the exposure is required (see page 28).

For the two months immediately bracketing the summer months or if the sun is lower in the sky or if the sky is overcast, double the indicated exposure. If more than one of these conditions prevail, double the exposure for each factor.

Exposure in the wintertime around noon: with snow – use the normal values of the table, without snow – multiply exposure by 4.

The table, although not always exact, has nevertheless proved itself so good that serious exposure errors are generally avoided. In difficult cases or for greatest accuracy, it is advisable to use a photo-electric exposure meter.



1/500 . 1:8 . filter light yellow

Action Stopping required (= fast shutter speed)
Correct exposure is had by using correspondingly larger diaphragm opening.

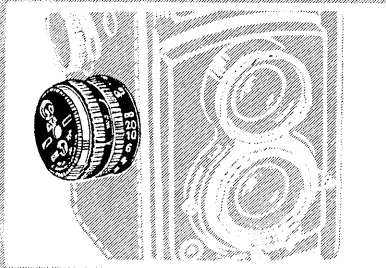

Auxiliary Focusing Knob with Film Indicator

A really practical aid towards obtaining correct exposures, the auxiliary focusing knob (page 57) contains two adjustable discs, variable according to film type and speed. Thus it is always possible to know what kind of material was last loaded in the camera. Furthermore, the larger, easier-to-grip shape and large footage scale facilitates accurate focusing under specially difficult working conditions, such as when using gloves in cold weather.

Speed of Photographic Emulsions

(Comparison values approximated)

Relative exposure	DIN	Scheiner (Europe)	ASA (BS)	General Electric	Weston
8	7/10	18	4	4,5	3
7	8/10	19	5	—	4
5	9/10	20	6	7,5	5
4	10/10	21	8	9	6
3,3	11/10	22	10	12	8
2,7	12/10	23	12	15	10
2	13/10	24	16	18	12
1,7	14/10	25	20	24	16
1,3	15/10	26	25	30	20
1	16/10	27	32	36	24
0,8	17/10	28	40	48	32
0,67	18/10	29	50	60	40
0,5	19/10	30	64	75	50
0,4	20/10	31	80	100	64
0,33	21/10	32	100	120	80
0,25	22/10	—	125	150	100
0,2	23/10	—	160	200	125
0,17	24/10	—	200	250	160

The characteristics of the different rating systems do not permit a direct mathematical conversion. However, the approximate comparison values of the table offer sufficient information for most practical purposes.

III. FLASHLIGHT TECHNIQUE

In modern flashlight technique the camera shutter takes over the task of firing the bulb electrically at the right moment. In this way instantaneous flash exposures are possible with a hand-held camera.

The Synchro-Compur shutter in the Rolleicord is, for this purpose, equipped with electrical contacts. The contact may be adjusted to the required delay of the flash lamps by means of the Synchro-lever:

the **X-contact** presents the simplest type of contact (zero-delay). It is required for zero-delay electronic flash units (without relay) and a few flash lamps.

The **M-contact** means full synchronization. It works with most flash lamps and the electrically fired flash powder (capsule flash). The most important advantage of the M-contact: with certain flash lamps it may be employed at the shorter shutter speeds even including 1/500th sec. Due to the full synchronization the shutter is always open when the flash emitted by the lamp reaches its peak intensity.



Thus all types of instantaneous flash exposures are possible with the Rolleicord.

The selection of flash lamp-type depends on the light output required by the subject. Many makes are available in three groups (normal, medium and high light output). The selection is dependent on the taking conditions, especially as to whether a room of shallow or great depth is to be illuminated.

Selection of M-X lever position, applicable speed range and exposures can be learned from the instructions of the different flash light products. Since the development of flash light sources still is in the experimental stage, numerous makes of varying efficiency are available commercially. For the best known makes the table on page 30 contains the necessary information and the permissible shutter speeds.

The flash attachment is connected to the camera by means of the flash cable, plugging into the special socket provided therefore. When setting contacts X or M: swing Synchro-lever a full 180° until it stops!

Flash-Contact and Permissible Shutter Speeds

FLASH LIGHT SOURCE		Contact	Shutter Speed: Fastest Slowest Recommended
Make	Type		
I. Electronic Flash			
General Electric	Without Relay (1/2000)	X	1/500 1/250 1
Westinghouse	SM (1/200)		
Sylvania	SF (1/200)	X	1/100 1/100 1
Osram	F0 (1/100)	X	1/50 1/50 1
	F1, F2 (1/50)		
	XP, X0 (1/200)	X	1/25 1/25 1
II. Flash Lamps			
Osram	S2	M	1/500 1/25 1
	S0, S1		
Philips (Mazda)	PF3N, PF14, PF25, PF56		
General Electric	No. 5, 11, 22	M	1/500 1/50 1
	Westinghouse		
Sylvania	Press 25, 40, Nr. 0, Bantam 8		
	No. 2	M	1/100 1/50 1
Philips (Mazda)	PF110		
General Electric	No. 50	M	1/50 1/25 1
	Westinghouse		
Sylvania	No. 3		
General Electric	No. 6, 31	M	1/250 1/25 1
	Westinghouse		
Sylvania	FP26, No. 2 A		
III. Capsule Flash		M	1/100 1/25 1
	Average		

Explanation of the Table

The "**Contact**" column indicates the correct setting of the M-X lever for each lamp type.

The "**Shutter Speed**" column shows the permissible speed range:

Center: the recommended shutter speed includes practically the entire light output of the flash lamp. This assures the maximum illumination as well as the smallest diaphragm (for greater depth of field). The following applies as a general rule:

Use the standard recommended speed together with the correct setting of the M-X lever for the lamp in use.

Left: the fastest speed indicates the limit to which the shutter may be set. For lively action or sports subjects, the faster speeds are employed.

Right: the exposure time may be increased to the slowest speed (1 second or even time exposures), if, in addition to the flash, it is desired to make use of existing light. In such cases the total amount of

light from all sources must be considered in choosing the diaphragm opening.

The Effective Exposure Time (as indicated in the table by means of **colored ink**) is not in each case identical to the shutter speed, but depends on the portion of the flash lamp light output utilized:

With X-Contact the duration of the flash itself is actually shorter than any of the permissible shutter speeds. Therefore, the light duration of the flash (specified in parenthesis after the make) will be the actual, constant exposure time so that the selected diaphragm opening must be maintained even when using slower shutter speeds.

With M-Contact the shutter speeds, from "fastest" to "recommended" fall within the duration of the flash: they therefore represent the actual exposure time and if the shutter speed is increased, the diaphragm must be opened accordingly. Only when slower shutter speeds are employed is the fully utilized light output equal to the actual exposure time, and this is the same as the recommended speed.

The illustration should make the utilization of the available flash light still more obvious: the white symbols represent the flash, and their size, the utilized light at the shutter speed employed.

How the Flash Contacts Work

The information given thus far is entirely sufficient for normal purposes and is adequately supplemented by the exposure tables usually furnished by the various flash lamp manufacturers.

The photographer who is familiar with and habitually makes use of flash lamp graphs should know something about the method of operation of both flash contacts.

X-Contact (zero-delay): contact is made shortly before the shutter blades reach full opening. Application: for lamps with short firing time (up to 5 milliseconds) and short flash duration.

M-Contact (full synchronization): contact is made approximately 16.5 milliseconds before the shutter blades are fully opened. Application: for flash lamps with long firing time (average firing delay 16.5 milliseconds) and long light duration.

For safety reasons one pole of the contact is grounded to the camera body (isolation-test: 700 volts). All commercially available flash guns and electronic flash units may be used. Current-carrying capacity of the contact when several flash lamps are connected simultaneously: 10 ampères at 24 volts for a period up to a maximum of 1/10th sec.

Tips on Flashlight Photography

1. Use fresh batteries. Condenser or capacitor flash-guns are more consistent since lamp ignition is somewhat less dependent on battery power.
2. Be sure that the contacts of the battery and lamp sockets are clean. Handle flash cable with care, avoid kinking, otherwise there will be danger of short-circuit and premature flash ignition. – Note: the contact must not be connected to house current!
3. Blue flash lamps, like electronic flash, simulate daylight and are intended for use with daylight color film.
4. The power of flash illumination decreases according to the square of the distance: i. e., an object six feet away receives only one-fourth the light as an object at three feet. Distance from flash to subject must therefore be carefully considered in selecting diaphragm opening. Lamp manufacturers supply easy to use guide numbers which are divided by the distance in feet to obtain the required diaphragm opening.
5. Flash as main light source: do not take weak room illumination into account, expose strictly according to flash output.

6. Flash as fill-in light: useful in brightening shadows whether due to insufficient illumination or to the fact that the picture is being taken "against-the-light", in full sunlight. The fill-in light must be kept at a lower intensity level than the main source of illumination, otherwise the strong flash will give an unnatural effect, not at all like daylight. Too strong a flash might even cause an apparent underexposure of the sky or the area not reached by the light. Electronic flash units are particularly well suited for use as fill-in lights when shooting color sports pictures. Use smaller lamps or keep them at greater distance.

7. Reducing the blinding effect of flash: The flash from regular flash lamps may be made "invisible" by dip coloring the bulb. Color solution No. 1 (200 cc. warm water + 10 cc. glycerin + 4 grams methylviolet) is used for panchromatic films. Open diaphragm 2 stops. Tone values are not changed in the picture. Additional dipping in color solution No. 2 (200 cc. water + 10 cc. glycerin + 4 grams tartrazin) will do for infra-red film. Open diaphragm 3 stops.

8. Developing: normal development of electronic flash pictures tends to produce insufficient contrast due to the very short time that the light is allowed to act on the film. The remedy is to develop longer or use special "hard" developers.

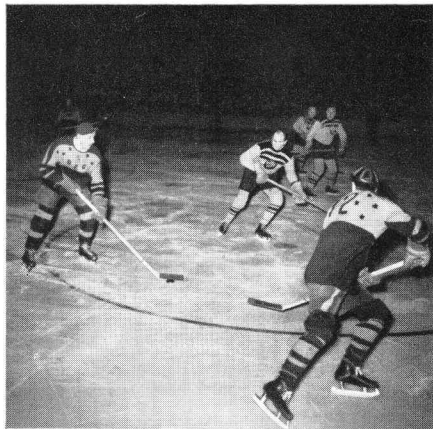

1:4
electronic flash

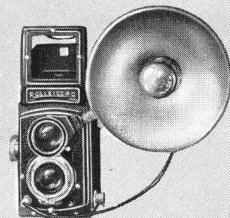

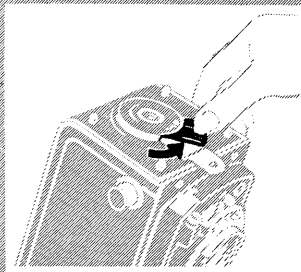

1

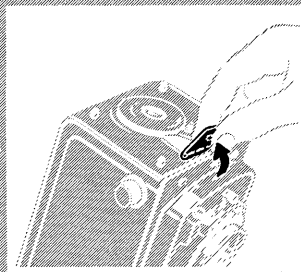

2

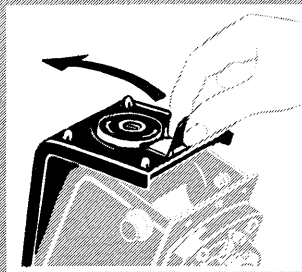

3

IV. LOADING AND FILM TRANSPORT

The Rolleicord is designed for use with No. 120 or B II 8 (not 620) roll film and delivers twelve $2\frac{1}{4} \times 2\frac{1}{4}$ pictures. (See note p. 35.)

The loading of the camera is divided into the following operations: open the back, insert the full film-spool, wind film to set indicator marks opposite red dots, close the back. Continued advance of the film is accomplished through rotating the film winding knob until it stops.

Back

To Open: swing aside the back locking lever at the bottom of the camera (1), lift the clip (2), open back (3), using the clip as a handle.

To Close: with the flat of the hand push the back closed, fold down the clip and return locking lever to full forward position.

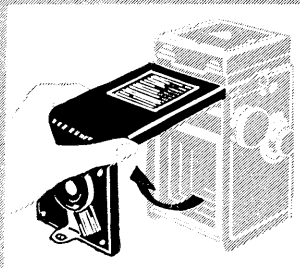

4

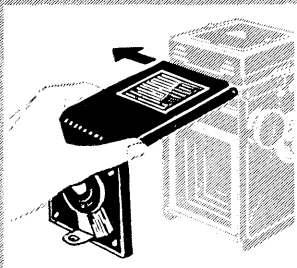

5

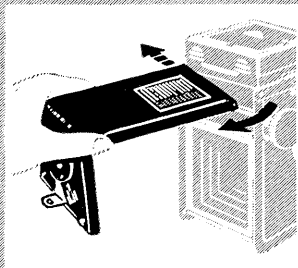

6

The back of the camera is generally removed only when replaced by the plate adapter.

To detach: open back widely (4), push it sideways against the spring hinge (5) and remove it to the rear (6).

To attach: first connect the detached back pin to the spring hinge and then slip other pin into the second hinge.

The plate back adapter is also attached to the camera in this manner.

Note: for the Rolleicord the following adapter accessories are also available: Rolleikin 2 Attachment for 36 exposures 24×36 mm. or 35 mm. film, Plate Back Adapter for separate exposures 2¹/₄×2¹/₄ on plates or cut films 2¹/₂×3¹/₂.

Protect the open camera against prevailing dust and clean it occasionally with a soft camel's hair brush!

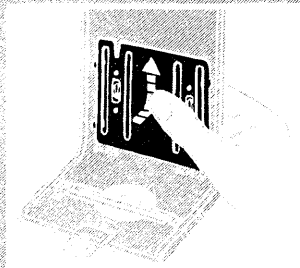

1

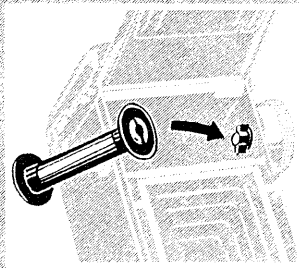

2

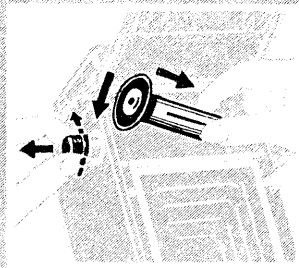

3

Film Pressure Plate Must be Positioned Correctly!

When roll film is employed, the inscription $2\frac{1}{4} \times 2\frac{1}{4}$ " must be visible below the film pressure plate. When changing from 120 roll film to 35 mm. film, or the reverse, an adjustment must be made according to the film type being used.

To adjust the film pressure plate (1): press the plate against the back and push it up or down until it stops. When released it must spring forward completely into the normal plane!

Inserting the Film Spool

In the factory-new camera the empty spool (take-up spool) is already in position. After removal of the exposed film the just emptied spool becomes a take-up spool, and must be transferred to the upper spool-chamber. The end with the slot goes to the right engaging the winding key of the film transport mechanism (2).

Both spools are held on the left hand side by spool knobs. The bearing pins are withdrawn when changing spools by pulling out the knobs.

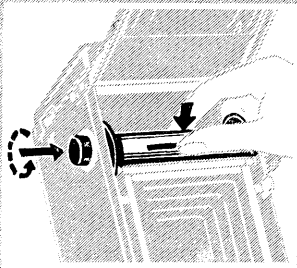

4

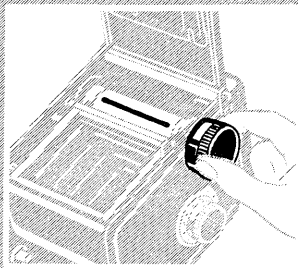

5

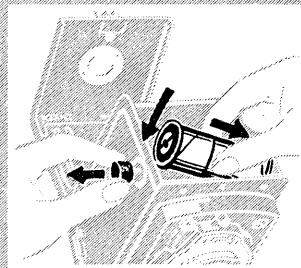

6

The pulled out upper knob (take-up spool) may be held in that position by turning it slightly; turning it a little more permits it to snap back by itself.

To Insert the Empty Spool: first fit the spool over the winding key on the right (winding knob side) and pull out the take-up spool knob (3). Push spool down on the left so that the knob may snap back into place fully (4). It is then necessary to turn the winding knob until the long slot in the empty spool comes uppermost (5).

Note: when using the plate adapter the empty 120 (or B 2) spool is removed from the camera. However, it must be handily retained especially on trips, since otherwise a new roll film cannot be loaded into the camera.

To Insert a Full Film Spool: in the same way as applies to the take-up spool (6). The pointed end of the backing paper must point in the direction of the take-up spool chamber, so that the colored side of the backing paper remains on the outside.

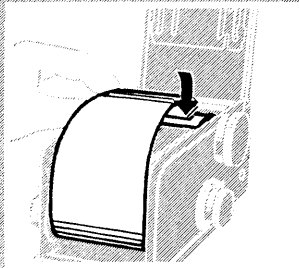

1

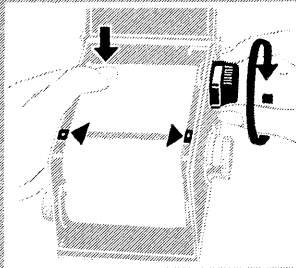

2

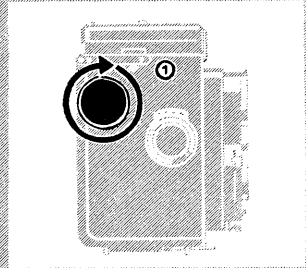

3

Starting the Film

After inserting a full film spool break the seal and remove it.

1. Pull the beginning of the backing paper up to the take-up spool, printed side outwards, and insert the tapered end into the long slot of the take-up spool as far as it goes (1).

2. Wind up the backing paper by turning the film

winding knob until the triangular marks (or double arrows) are in line with the red indicator marks on both sides of the film aperture (2). Check to see that film pressure plate is in correct position and wind film evenly, using thumb as a brake.

Close the back, and lock.

Engage double exposure prevention lock.

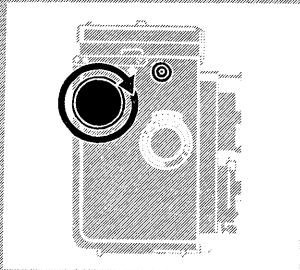

4

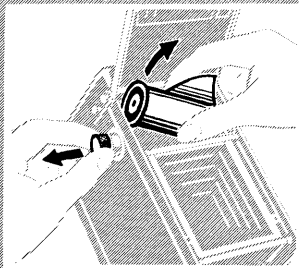

5

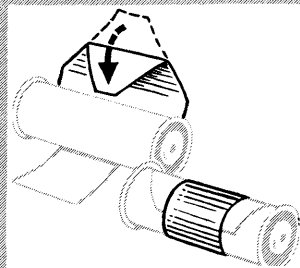

6

Advancing Film

Turn winding knob until it stops (3). The shutter tensioning and release lever thereby remains in "rest" position.

Removal of the Film

After the 12th exposure: wind off the film with some six complete revolutions of the winding knob (4).

Removal: open back in shady spot, pull out take-up spool knob and lift film out from left side (5). Fold under a good portion of the backing paper (for easy opening when developing) and seal with tape (6). Put the exposed film back into the light-proof protective cover of the original package!

Never change film in direct sunlight! Utilize, at least, the shadow of your own body.

V. TIPS ON PICTURE-TAKING

Landscapes

Focusing rule: distant views with foreground. Focus on part of subject nearest to camera and then set focusing knob to twice the distance – use diaphragm setting indicated opposite ∞ . Example: close point is 15 ft, set focus to 30 ft, diaphragm opening indicated opposite ∞ is f:11. Depth of field is from 15 ft to ∞ .

Filters: important for separating tones, which would otherwise be similarly rendered by the black and white film, or for influencing the mood of the picture.

1. Blue sky with clouds: yellow filters darken blue skies and thus improve the reproduction of clouds. The deeper the color of the filter, the stronger and more dramatic the effect. Blue snow shadows are also rendered truer to tone. The green filter tones down the sky, brightens foliage and darkens the occasionally too lightly rendered reds (with pan film) such as sun-tanned flesh and red tile roofs.

For filtering the sky but not the landscape: when pictures are taken with “back towards the sun” the Rolleipol filter darkens the blue sky only by eliminating the polarized light.



1:8 . 1/100
filter yellow



2. Haze and mist: the blue filter, useful for pictorial effects, increases hazy effect, The orange or red cut through and improve the clarity of distant views. The blue filter reduces contrast, the red or orange increases brilliance. Maximum penetration of light haze is obtained with infra-red film and infra-red filter (700 m μ). Barely visible mountain chains are reproduced clearly. An odd effect with this combination is that green leaves are rendered almost white. Filters are of no use at all in really bad weather when there is a considerable amount of moisture in the air.

3. Sea, Beach, Mountains: strong ultra-violet rays must be absorbed through use of U.V. filter. Results will otherwise be dull. The H 1 filter serves the same purpose for daylight-color film. Reduction of the bluish cast is quite marked.

Picture composition rules: distant views are generally better if foreground contains (for added depth impression) trees, people, animals, etc. Foliage is often used as a frame for the distant view. Focus should be sufficiently sharp in the foreground. Strong effects are created when deep shadows in the foreground are set against the lighter distance. Side lighting or even back lighting gives the most impressive pictures.

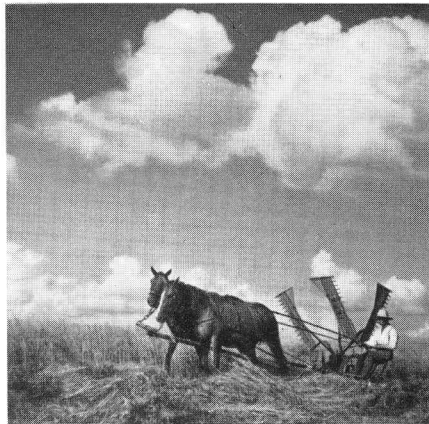

1:8 . 1/50
filter green

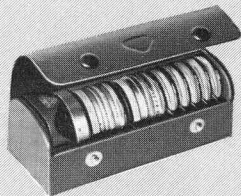



1:8 · 1/100



Portraits

Large heads: do not work closer than 40 inches to avoid possible perspective distortion. If necessary, enlarge from a smaller section or use Rollei-kin. Focus on the eyes. Use quiet, neutral colored backgrounds and do not stop down too much (f:5.6) so as to keep backgrounds from intruding. If possible, move subject away from background. Out of doors, try using sky only as background. Open air portraits are best taken early or late in day when light is softer and not too blinding. Favor soft light, avoid deep shadows. In emergencies use reflectors or fill-in flash. Simple, proven artificial light procedure: lamp No. 1 next to camera somewhat above head level, lamp No. 2 on the side to lighten shadow, approximately 1/25th sec. For special effects, lamp No. 3 as overhead or back-light. Important: use lens hood and focusing extension hood for reducing extraneous light. Pan film, no filter. Moisten lips (highlights!). To reduce sharpness and add "glamor": Rollei soft diffusion disc 0 or 1 (stronger) over lens. Use larger diaphragm openings and backlight for sunny effects.

Children

Never use force, watch for interesting effects and expressions carefully. A clever assistant to divert children's attention from camera is often a valuable aid. Try close-up shots of children's expressions as they listen to favorite or exciting stories. Laughter, astonishment, pity and even an occasional yawn provide wonderful material for good shots or picture series. For close-up shots use same technique as for portraits. For children in motion, use snapshot technique outdoors and flash indoors. Low viewpoints and close-up effects are best.

Animals

Patience, quietness and familiarity with the animal and its peculiarities are great assets. Close-up pictures are most rewarding; use portrait technique. Make use of natural light effects such as backlighting. Action pictures: use snapshot or sport technique (with flash, if needed). Rolleinar are often helpful with small animals. Zoo: animal portraits – avoid bars or netting. Hint: netting often becomes invisible when lens nearly touches wire. – Fish in aquarium: use side and overhead lighting in otherwise darkened room. A good trick is to limit movement of fish within sharp zone by means of vertical glass plate in tank.



1:4 · 1/50
Rolleisoft 0



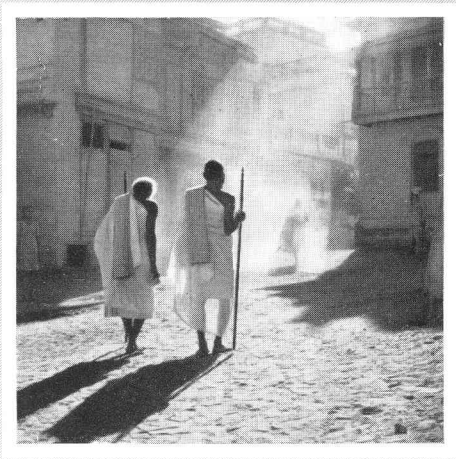

1:11 · 1/50 · filter light yellow

Snapshots

Unexpected picture opportunities or rapidly changing subject distance make a simplified technique, based on depth of field zones, highly desirable. The following three settings have been found very effective:

1/100 sec.

Diaphragm opening f:8

Short distances approx.	Medium distances approx.	Long distances approx.
9 to 18 ft	13 to 33 ft	18 to 100 ft

12 ft

20 ft

30 ft

Shutter speeds and diaphragm openings do not often need changing in sunlight. Those suggested cover most contingencies. Thus instead of wasting time focusing when in a hurry, use one of the above settings. This snapshot technique is especially useful with the direct view finder. Variation of the values (see table, p. 21) makes this technique available for other depth of field zones. Example: diaphragm opening f:11, focus at 30 ft, depth of field extends from 15 ft to ∞ for snapshots of scenes. Chief uses for this technique: groups in motion, sport scenes, playing children, reportage, sports.

Sports

Sports pictures are generally most effective when the original rapid motion has been sufficiently "arrested" and the subject remains well defined. The fastest shutter speeds are essential, together with careful focusing. Sometimes pre-focusing on the spot where the action is to take place is possible. Do not overlook the possibilities of training sessions, since greater cooperation can often be had at such times. Snapshot technique is valuable for turf and ice shots and for any case when it would be difficult to guess exactly where to focus. Watch your shutter speeds and viewing angle. Shooting at right angle to the direction of the action requires a much faster speed than when the action is going in other directions (see table page 23). If the action is very fast or takes place close to the camera, it is best to pan or follow with the camera. This results in a sharply rendered main object against a blurred background, thus increasing the impression of speed. There is often a fine moment for shooting when the action reaches a peak and stops momentarily, such as when a pole-vaulter "hits the top" before starting to come down again. With insufficient light or indoors use synchro-flash and 1/500 th sec. The extremely short duration of electronic flash is highly desirable in some instances. Use the direct view finder; do not overlook the advantages of the Rolleikin with its telephoto effect, maximum use of film arae and greater film capacity.



1:4 · 1/250

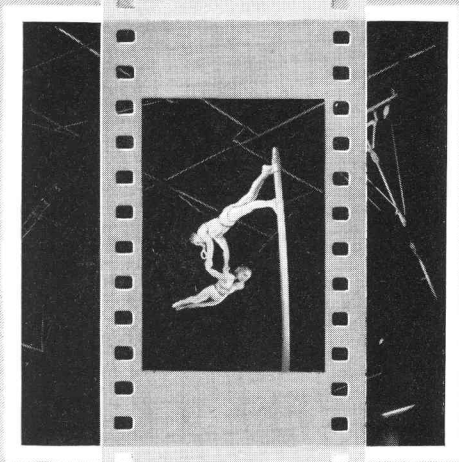

Theatre and Music Hall

At longer distances only a section of the film is generally used hence this is a good field for using the Rolleikin. Do not depend on footlights but concentrate on spotlighted performers or features. Exposures of 1/25th sec. are generally adequate under the strong lights with fast pan film. Color-dipped flash lamps (see page 33) permit flash exposures without disturbing spectators. After pre-setting focus you can use direct view finder most comfortably.

Night

Include direct light sources as symbols of the night in the picture. Only very strong, close lamps must be hidden behind natural foreground objects (building, tree, persons), otherwise overexposure will result. Make use of effects: reflections in wet streets, light deflected by snow, early twilight with traces of brightness in the sky. Use fast pan film only. For time exposure: cover up lens when auto headlights cross the picture area, to avoid streaks. Use flash for snapshots at night, not for night shots.

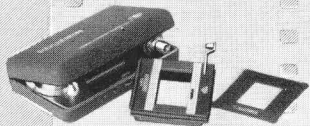

Copying

Smaller originals are best copied with Rolleinar. See table page 55 for reproduction sizes. The camera should be set on a rigid, vibration free stand with the original parallel to the film plane. Use a small stop; f:11 recommended. Light evenly from both sides but avoid reflections. Glossy surfaces give less trouble if Rolleipol is used. Colored originals may require filter for better tone separation. Use contrasty ortho film (or even positive film with Rolleikin) for black and white originals. Spots on originals can be minimized by using a filter similar in color to spot with pan film. The Rolleikin is especially valuable for series or archive work. Single reproductions are economically taken with the plate back adapter. Reproductions from books are readable with ordinary magnifier directly from $2\frac{1}{4} \times 2\frac{1}{4}$ contact prints. Small objects (small machine parts, assembly pieces) may be handled similarly to copying. A spotlight can often be an additional aid in this case. Shadowless lighting effects are facilitated by placing object on a suspended glass plate. Reflections from fine glassware or other highly reflective objects can be reduced to a minimum, if the object is photographed by reflected light such as can be had inside an illuminated, white painted box.

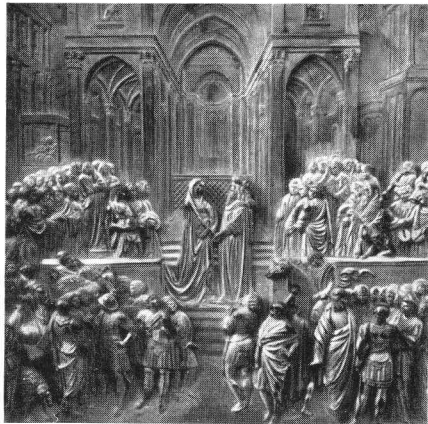

1:8 · 1/50

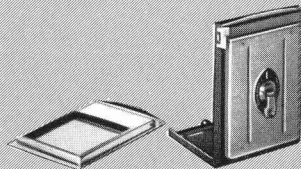



Panorama Pictures

Special landscape pictures of distant views, which include a large portion of the horizon, are made possible with the panorama head when used in conjunction with a tripod. Either a few succeeding exposures can be made for normal panorama purposes or up to ten can be taken in order to cover the complete (360°) horizon. The separate pictures can be joined so that nothing is missing. When exposing: watch for any change in illumination and take pictures quickly if clouds are moving briskly.

Rolleigrid Lens

Covering the ground glass screen with this new field lens (Fresnel type) will considerably brighten the image at the edges. Critical focusing is easily accomplished through the clear center portion of the grid.

To install: place the Rolleigrid with the narrow front edge against the ground glass screen, let it slide forward under the retainer tab, then drop the rear end and fasten by means of the push-button at the rear of the focusing hood (p.16). The condenser must be placed on the ground glass with the grooved side down.

The Practical Accessories for the Rolleicord IV

Code:		Code:	
Becor	Ever Ready Case for Rolleicord IV	Etlee	Leather Case (without contents)
Baobe	Lens Hood	Focom	Complete Plate Adapter Equipment comprising: 1 Plate Adapter, 3 Slides, 1 Focusing Screen Slide, 1 Leather Case for 2 Slides
Baihe	Rollei Yellow Filter, light	Foapt	Plate Adapter
Baimi	Rollei Yellow Filter, medium	Fosli	Slide
Balin	Rollei Green Filter, light	Fopla	Cut-Film Sheath
Baen	Rollei Green Filter	Focas	Leather Case for 2 Slides
Basky	Rollei UV Filter	Fofoc	Focusing Screen Slide
Baora	Rollei Orange Filter	Rolki	Rolleikin 2
Baubi	Rollei Red Filter, light	Foad	Panorama Head
Babla	Rollei Blue Filter, light	Fohod	Extension Hood
Bahaz	Rollei H 1 Filter (UV Filter for Daylight Color Photography)	Fogri	Rolleigrd Lens
Bafir	Rollei Infra-Red Filter	Comek	Auxiliary Focusing Knob (meter) with Film Indicator
Batnu	Rolleisoft 0	Cokfe	Auxiliary Focusing Knob (feet) with Film Indicator
Baton	Rolleisoft 1	Blika	Connecting Cord for Flash Attachment 16 in.
Batar	Rolleipol	Cekab	Extension Cord for Flash Attachment, 10 ft.
Bapun	Rolleinar Lenses, set 1 (40-18 in.)		
Baodo	Rolleinar Lenses, set 2 (20-12 in.)		
Baken	Rolleipar Lens 1		
Bakdu	Rolleipar Lens 2		
Etcom	Leather Case containing: 1 Lens Hood, 2 Sets of Rolleinar Lenses, 2 Rolleipar Lenses and your choice of 5 Filters		

To avoid errors when ordering accessories please specify camera-number.

Full information on the use of Rollei accessories in the booklet "The Practical Accesories".

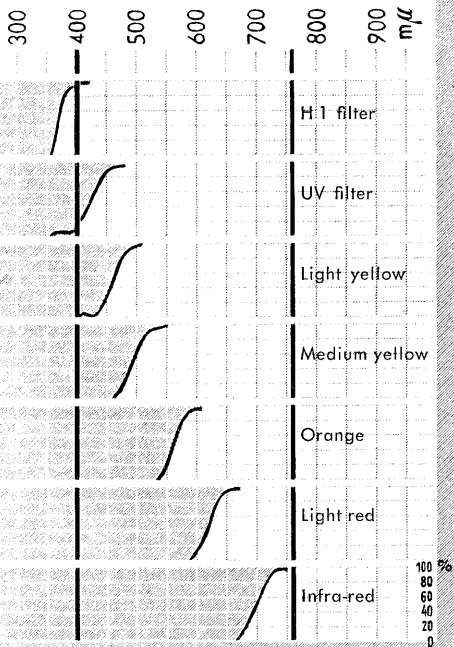

Pictures Through the Microscope

When a microscope is focused by someone with normal eye-sight, the eye sees the image as if it were at infinity. Consequently, the Rollei, also focused at infinity, can simply take the place of the eye over the microscope in order to record the image on film.

Microscope and camera should be mounted on firm stands, without mechanical connections. Place the camera so that taking lens, focused at ∞ , is brought as close as possible to the ocular. Check optical axis carefully; film plane should be parallel to surface being photographed. For full coverage of $2\frac{1}{4} \times 2\frac{1}{4}$ use wide angle ocular, however, sufficient coverage for Rolleikin negative is to be had in any case. Framing through view finder is unnecessary. Do not stop down since this has no effect on exposure. Factors affecting exposure are illumination and transmission of the objective, to be ascertained through tests. Apochromatic micro-lenses are best, particularly with color film. In shooting black and white with these lenses, use ortho material and green filter. Generally interesting are micro-pictures of crystallized chemicals through Rolleipol filter in conjunction with another pola-filter over microscope condenser.

Care of the Rolleicord

A precision camera demands care in handling. Protect it against moisture, dust, sand, strong sunshine, hard blows or falls. First safeguard: the ever ready case. Second safeguard (when not in use while traveling): a rubber bag to guard against water, sand or snow. Carry camera around neck to minimize transportation shocks. Keep all parts clear and clean lenses with a soft camel's hair brush or doeskin. Although the mechanism is not unduly sensitive to cold, some condensation may form on the lenses when the camera is brought in to a warm room from outside in cold weather. Do not wipe off - let moisture evaporate. In the tropics arrange to keep the camera, when not in use, in an air-tight container.

In Case of Damage to the Rolleicord

The task of repairing major or minor damage is the special province of the expertly trained mechanic. Franke & Heidecke maintain their own special workshop in which all repairs are done with precision at nominal prices. Abroad, apply to photo dealers and factory representatives for full information.

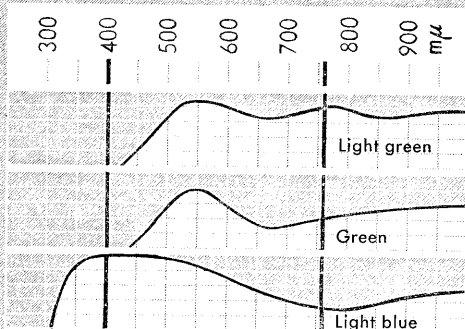

The filter curves show the absorption of the various Rolleiflex filters in the spectral ranges ultra-violet, visible spectrum blue to red (appr. 400-760m μ), and infra-red. This means: darker portion of the spectogram = absorbed light; lighter portion = useful light. The light-transmission of the filter from the lowest point to the peak point of the curve thus increases from 0 to 100%. While the H 1 filter cuts out the short wave ultra-violet portion of the spectrum, the green filter absorbs a substantial portion of the long wave red and infra-red range.

Table of Rollei Filters

The filter factors indicate average values which, however, may be changed according to the particular type and make of film used and the light conditions.

Rollei Filter	Use	Filter Factor	
		Ortho	Pan
Light yellow	Landscapes, snow, clouds. Renders yellow and green lighter, blue darker.	3 x	2 x
Medium yellow		4 x	3 x
Light green	Landscapes, snow, clouds. Renders green lighter, red (complexion) and blue darker. For pan emulsions.	3 x	2 x
Green		4 x	3 x
Orange	Hazy distant views. Renders yellow-red lighter, blue darker, distant objects clearer.		3-7 x
Light red	Hazy distant views. Renders red lighter, blue-green darker. Gives stronger effects than Orange Filter.		4-10 x
Light blue	Artificial light. Renders red darker. For ultra-pan emulsions.	1.5 x	1.5 x
UV	High altitudes above 6000 feet. Seascapes. Eliminates ultra-violet rays which reduce contrast.	1.5 x	1.5 x
Infra-Red	Special filter for infra-red emulsions. Transmits dark red above 700 m μ and infra-red.		*)
H 1	UV-Filter, especially designed for long distance color photography. Absorbs ultra-violet rays, subdues predominance of blue and cuts aerial haze in distance shots.		No increase of exposure

*) Exposure depends on the type of emulsion used and must be determined by tests.

Focal Length and Focusing-Range with Rolleinar Lenses

Rolleinar Lenses	1	2
Focal Length	75 mm	71 mm
Focusing-Range (in inches)	∞-32	39 ¹ / ₂ - 17 ³ / ₄
		19 ³ / ₄ - 12 ¹ / ₈

Field-Size and Scale of Reproduction

Focused Distance	31 ¹ / ₂ in.	19 ³ / ₄ in.	13 in.
Field-Size (in inches)	2 ¹ / ₄ x 2 ¹ / ₄	13 ³ / ₄ x 13 ³ / ₄	8 ³ / ₄ x 8 ³ / ₄
(in Rolleikin)	9 x 12 ¹ / ₂	5 ¹ / ₂ x 7 ¹ / ₈	3 ¹ / ₂ x 5 ¹ / ₈
Scale of Reproduction approx.	1 : 10	1 : 6.3	1 : 3.9

Depth of Field with Rolleinar Lenses

Rolleinar	1		2		f / Stop
Focused Distance (in inches)	31 ¹ / ₂	23 ¹ / ₂	19 ³ / ₄	15 ³ / ₄	
from to	29 ¹ / ₂ 33 ¹ / ₂	22 ¹ / ₂ 24 ³ / ₄	18 ⁷ / ₈ 20 ¹ / ₂	15 ¹ / ₈ 16 ¹ / ₂	5.6 8
from to	28 ³ / ₄ 34 ¹ / ₄	22 ¹ / ₄ 25 ¹ / ₄	18 ³ / ₈ 20 ⁷ / ₈	15 16 ⁷ / ₈	11
from to	28 35 ³ / ₄	21 ⁵ / ₈ 26	18 ¹ / ₈ 21 ¹ / ₄	14 ⁵ / ₈ 17 ¹ / ₄	16 22
from to	26 ³ / ₄ 38 ¹ / ₄	20 ⁷ / ₈ 27 ¹ / ₄	17 ³ / ₄ 22	16 ⁷ / ₈ 23 ¹ / ₄	
from to	25 ¹ / ₄ 41 ³ / ₄	20 28 ³ / ₄	16 ⁷ / ₈ 23 ¹ / ₄	14 ¹ / ₄ 18 ¹ / ₈	

Taking-distance measured from lens panel to object. Permissible circle of confusion in this special case (due to the large image and less need for enlarging) = f/1000. For increased sharpness further stopping down is required.