

This camera manual library is for reference and historical purposes, all rights reserved.

This page is copyright by mike@butkus.org M. Butkus, N.J.

**This page may not be sold or distributed without the expressed
permission of the producer**

I have no connection with any camera company

If you find this manual useful, how about a donation of \$3 to: M. Butkus, 29 Lake Ave., High Bridge, NJ 08829-1701 and send your E-mail address too so I can thank you. Most other places would charge you \$7.50 for a electronic copy or \$18.00 for a hard to read Xerox copy. These donations allow me to continue to buy new manuals and maintain these pages. It'll make you feel better, won't it?

If you use Pay Pal, use the link below. Use the above address for a check, M.O. or cash. Use the E-mail of butkusmi@ptd.net for PayPal.



[back to my "Orphancameras" manuals /flash and light meter site](#)

Only one "donation" needed per manual, not per multiple section of a manual !

The large manuals are split only for easy download size.



Rolleiflex

3.5

Planar
Xenotar

I N P R A C T I C A L U S E

Rolleiflex

3.5

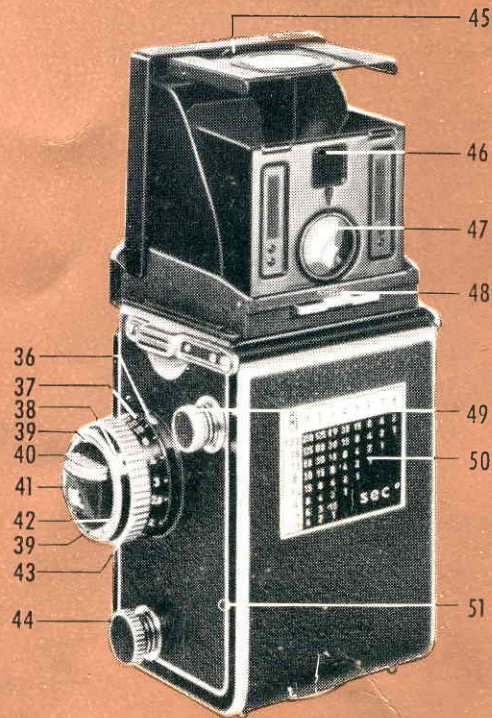
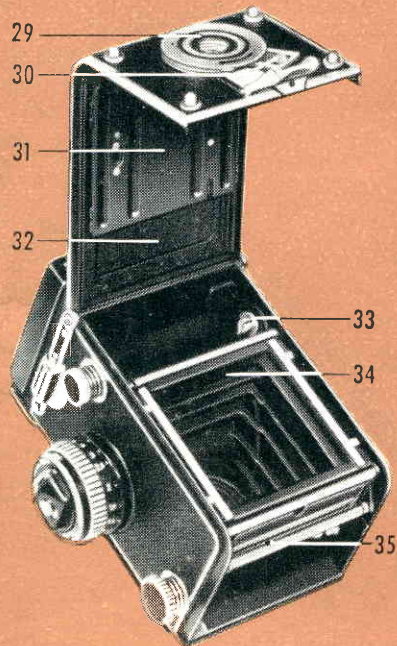
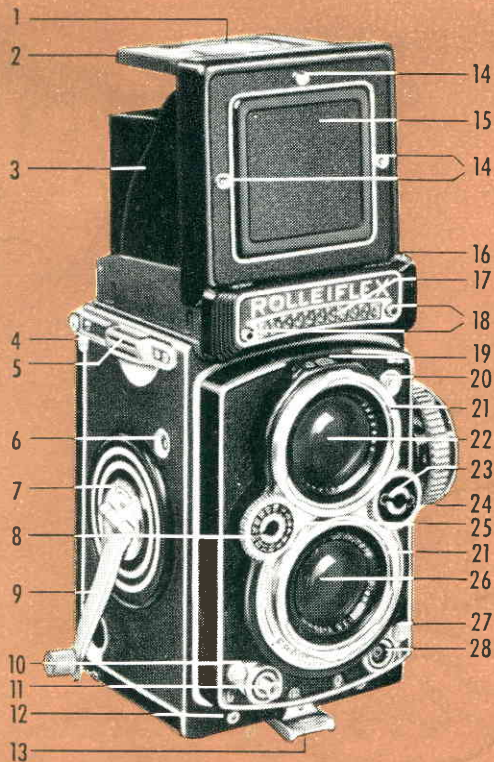

DESCRIPTION OF CAMERA*

(Detailed explanation → Page)

- | | |
|--|---|
| 1 Focusing magnifier → 16 | 26 Taking-lens |
| 2 Magnifier flap → 16 | 27 Synchro M-X lever with locking device for flash cord plug → 33 |
| 3 Focusing hood → 16 | 28 Flash cable socket → 32 |
| 4 Locking clip for back hinge → 37 | 29 Tripod socket → 37 |
| 5 Neck strap → 12 | 30 Back locking lever → 36 |
| 6 Film frame counter window → 40 | 31 Adjustable film pressure plate → 38 |
| 7 Crank release (to re-tension shutter for double exposures) → 30 | 32 Combination back for No. 120 (B II 8) and 35 mm film → 36 |
| 8 Light value scale → 24 | 33 Winding key for take-up spool → 38 |
| 9 Film advance and shutter tensioning crank → 30 | 34 Anti-reflection baffles |
| 10 Shutter release guard → 30 | 35 Automatic film feeler mechanism rollers → 40 |
| 11 Shutter release with cable release socket → 30 | 36 Automatic depth-of-field indication → 26 |
| 12 Locating sockets for panorama head | 37 Focusing scale → 26 |
| 13 Back lock clip → 36 | 38 Light value indication → 19 |
| 14 Pin-socket for Rolleikin direct view finder mask → 17 | 39 Adjusting for film speed → 19 |
| 15 Direct view finder panel → 17 | 40 Measuring portion of exposure meter → 19 |
| 16 Sensitivity range control → 19 | 41 Adjustment of film type and speed reminder → 19 |
| 17 Photo-cell → 19 | 42 Exposure meter adjustment ring → 19 |
| 18 Attaching diffuser → 20 | 43 Focusing knob → 26 |
| 19 Indicator window for shutter ana diaphragm settings → 26 | 44 Film-spool knob (Rolleikin rewinding knob) → 38 |
| 20 Self-timer release → 31 | 45 Magnifier lifting handle → 16 |
| 21 Double bayonet mount for lens accessories and lens hood (bayonet size II) | 46 Rear sight for direct view finder → 17 |
| 22 Viewing-lens | 47 Magnifier for eye-level focusing → 17 |
| 23 Locking button → 24 | 48 Retaining device for Rolleigrd lens → 16 |
| 24 Diaphragm control → 24 | 49 Take-up spool knob → 38 |
| 25 Shutter speed control → 24 | 50 Light value table for time exposures → 23 |
| | 51 Focal or film plane (focusing distances measured from this line) |

* Rolleiflex 3.5 with Xenotar, not provided with exposure meter, but design permits subsequent installation.

PREPARING TO SHOOT

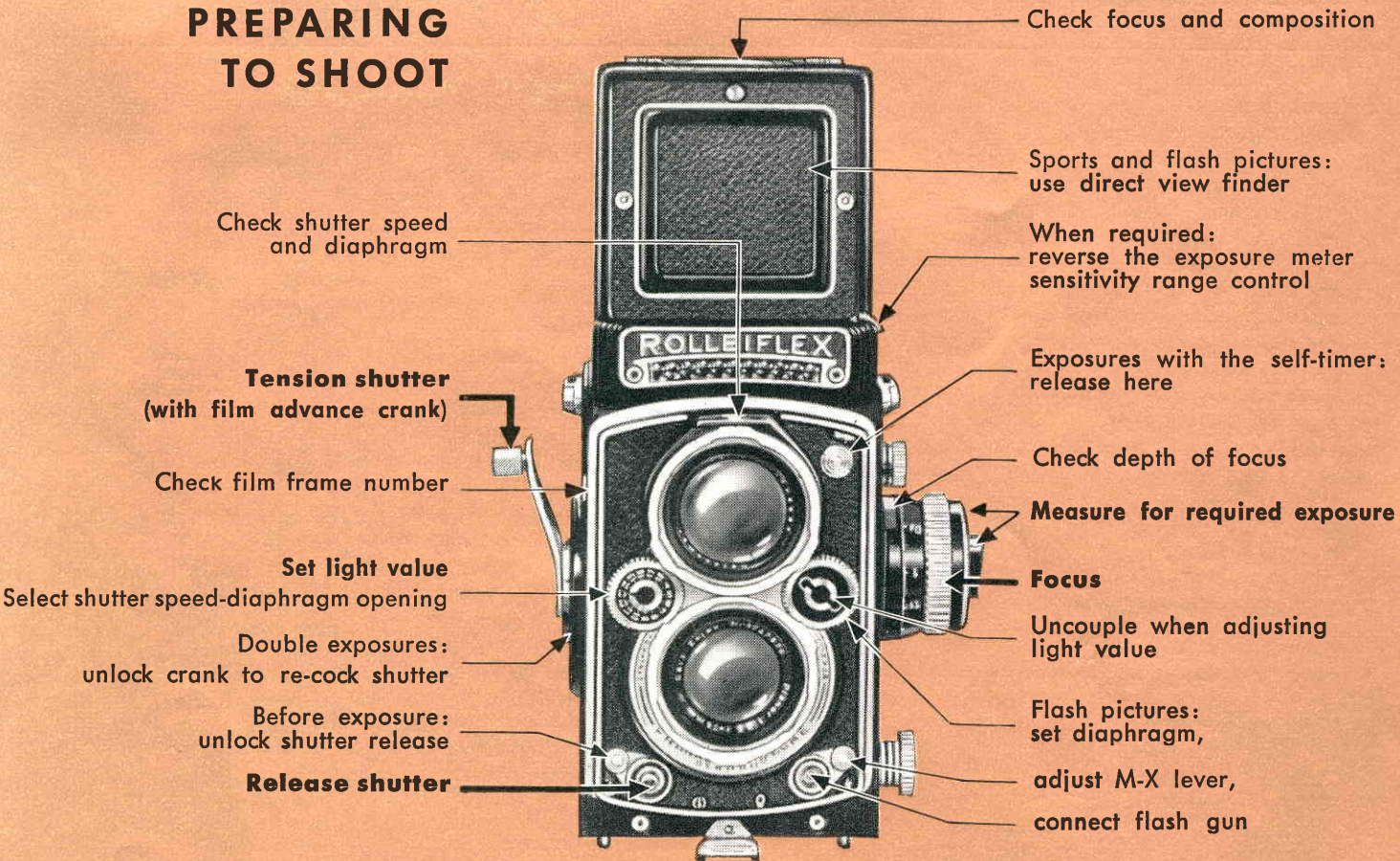

TO LOCATE THE MOST IMPORTANT PARAGRAPHS QUICKLY

As today's example of a practical precision camera, the Rollei offers not only the highest degree of performance and optical quality, but also all the ease of use one could wish for. Just three controls and three operations suffice for everyday use. Correct operation is simplicity itself. Because of the virtues of its design and construction, Rollei easily copes with all the special tasks that the photographer who wishes to take full advantage of his and its capabilities will set himself.

The following pages constitute a detailed "Instructions for Rollei-Photography" and therefore will be suitable even for later reference. The illustrations will quickly acquaint you with the handling characteristics and operations. Moreover, if you wish to get into photographic action immediately, note that everything important is especially emphasized by arrows in the following abstract.

Page:	Page:	Page:
6 I. A Brief Rolleiflex-Anatomy	→ 24 Light Value (shutter speed and diaphragm combination)	44 V. Tips on Picture-Taking
12 II. Rolleiflex in Operation	26 Sharpness and Depth-of-Field	Tables:
→ 12 Neck Strap	→ 30 Shutter Tensioning	22 Light Values
→ 12 Ever Ready Case	30 Releasing	23 Light Value and Time Exposures
→ 13 Lens Cap	31 Self-Timer	25 Speed of Moving Objects and Shutter Speeds
14 Holding the Camera	32 III. Flashlight Technique	29 Depth of Field
→ 16 Focusing Hood	36 IV. Loading and Film Transport	34 Flash-Contact and Shutter Speeds
→ 16 Focusing Magnifier	→ 36 Back	43 Speed of Emulsions
→ 17 Direct View Finder	38 Inserting the Film Spool	55 Color Conversion Filters
→ 19 Exposure Meter	40 Threading the Film	56 Rollei Filters
20 Measuring reflected and incident light	40 Film Transport	58 Rolleinars
	43 Film Reminder	59 Practical Accessories

I. A BRIEF ROLLEIFLEX-ANATOMY

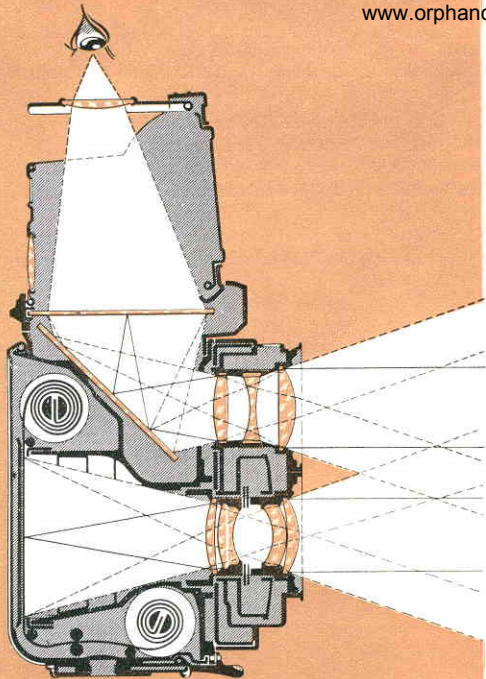

In the Rolleiflex two separate cameras are joined in a twin-camera with a common sturdy die-cast body: the bottom half is the

taking-camera, in which the film is exposed, and the upper half is the

viewing-camera, which is designed on the mirror-reflex principle. Its special task is to make the focusing visible on the ground glass and to supply a control image essentially similar to that of the prospective picture.

The image forming rays are transmitted by the fully open viewing lens, projected on to the ground glass screen via the mirror and the result is a right-side-up ground glass image, in the full size of the original picture. This viewing image is visible at all times and every detail of composition and framing may be watched even during exposure.

The ground glass screen is ruled with a number of vertical and horizontal lines making it possible to detect errors, such as lines which converge but should be parallel or a slanting horizon, in time to notice and correct them. It is easy to straighten or level the camera by means of the lines on the ground glass screen.

Above all, the ground glass screen provides the means for **focusing the camera**. This is accomplished by rotating the focusing knob. Both lenses, which are inflexibly coupled to each other by means of a sturdy common front plate, are thereby adjusted simultaneously: a sharp viewing image, therefore, guarantees an equally sharp picture. Since the Rollei-flex is equipped with a fast viewing lens and an optically prepared ground glass screen, the viewing image is extremely bright and clear and focusing can be done very critically.

The **focusing hood**, which is designed for one-hand operation, is kept in both open and closed positions by spring tension. It is equipped with a **magnifier** offering approximately 2.5 times magnification for critical focusing.

The rectangular magnifier flap also acts as a shield for the focusing hood and prevents extraneous light from above reaching the viewing image.

If the front panel of the focusing hood is pushed inward, it is transformed into a **direct view finder** through which the subject may be seen in natural size making it particularly easy to follow fast action. In this case it is still possible at all times to maintain control over focus: this is made possible by means

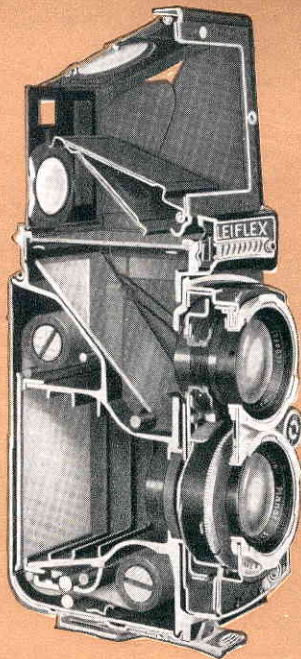

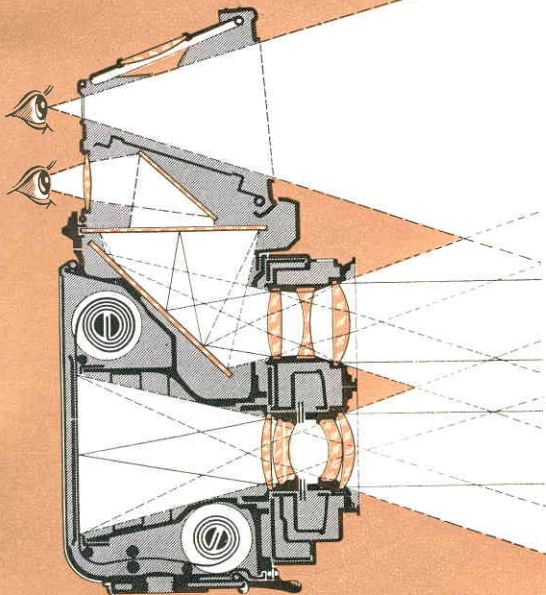

of a second magnifier in the back of the focusing hood, and a diagonally mounted mirror. A slight raising or lowering of the Rolleiflex is all that is required to alternate between the right-side-up open view in the direct finder, and the reversed center portion of the ground glass focusing image. The fact that the two finder openings are located so close together, enables quick framing of the subject after focusing. The usefulness of the open direct view finder is thereby enhanced for sports pictures.

Focusing the front lens panel throughout the range from ∞ (infinity) — 35½ inches (distances measured from the focal or film plane to the subject) is accomplished by one full turn of the focusing knob. The special design of the focusing mechanism (a cam-drive based on the principle of the archimedic spiral) insures uniform movement of the lens panel in both directions without play or backlash.

Tied in with the movement of the lenses is a simple sliding mechanism, located beneath the ground glass, providing completely automatic **parallax compensation**. Consequently, the final picture is always framed exactly as originally viewed on the ground glass screen. Similarly complete control is had even when using supplementary Rolleinar lenses for close-up work because of the prism which is built into the Heidosmat-Rolleinar.

The exposure meter is made up of the light sensitive element, or photo-cell, in the name plate of the camera and the measuring mechanism in the focusing knob. It can be adjusted for two ranges of sensitivity; In brilliant light the photo-cell is partially covered by an opaque shutter behind the honey comb lenses of the photo-cell. In dim light the photo-cell receives all the light coming through the honey comb for full sensitivity. The reading is supplied in the form of the light value for the film speed being used. The light value can be obtained by measuring the light reflected from the object or scene, or the incident light, through the attachable diffuser.

The **Synchro-Compur-Shutter** is adjusted automatically for the correct exposure when set to the previously determined light value. After this is done the two controls (speed and diaphragm) may be locked together by the very simply operated coupling button. Shutter speed and companion diaphragm opening may thereafter be changed at will, within the available range of operation, using a single control and without altering the exposure. Each speed-diaphragm combination appears, as the control is turned, in the peep window in front of the ground glass. When required the two controls may

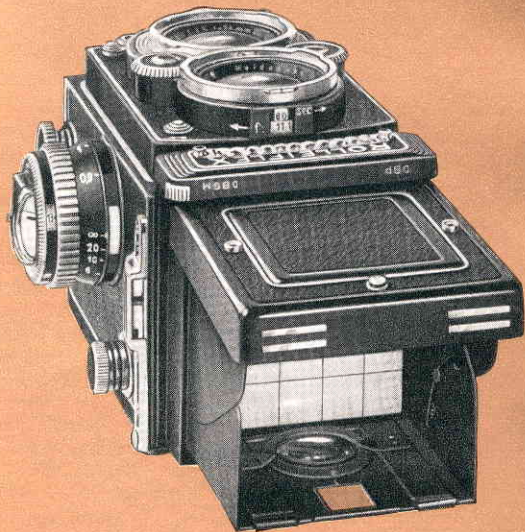

be separately adjusted by merely uncoupling the mechanism.

The **depth-of-field indicator** on the focusing knob is permanently coupled to the diaphragm and indicates by means of a white band, that portion of the field which is in the actual range of sharpness.

Since the two **lenses** are of identical focal length ($f = 75$ mm, picture angle [across diagonal], 56°) it follows that the image in both sections of the camera will always be critically focused on the same portion of the subject simultaneously.

The $f:3.5$ taking lens is a five glass construction with two cemented elements (modified Gauss-type) and features outstanding correction for black and white and color pictures, while the three-element viewing-lens $f:2.8$ meets with the special requirements for best ground glass focusing. Both lenses are treated with abrasion resistant coating. The bayonet receptacles circling the mounts are intended for attaching the lens hood and supplementary optical accessories, which in this way will be held in optically correct position and form a solid unit with the camera.

The removable **combination back** is attached to the camera by means of two hinges with automatic lock and at the bottom it contains the tripod socket and

the safety back lock. Its adaptability for the two picture sizes $2\frac{1}{4} \times 2\frac{1}{4}$ " and 24×36 mm is the result of the adjustable film pressure plate which can be set for 120 (B II 8)-film (with paper backing), or for 35 mm film (without paper backing) when used in conjunction with the Rolleikin attachment. In both cases a film channel is created with a width that corresponds to the thickness of the film being used. Thus the film can be properly held in the focal plane, and also can slide through without undue friction when advanced.

The quick acting **crank** coupled with an automatic gear mechanism performs six important functions with each pendulum swing: 1. advances film to next frame, 2. advances film frame counter, 3. tensions the shutter, 4. resets the self-timer mechanism, 5. releases shutter lock, 6. engages film lock.

The shutter release and film advance crank are locked and unlocked alternately, thereby offering full insurance against double exposures or skipped frames. For intentional double exposures the crank must be unlocked at the crank base: Turning the crank a full turn to the left cocks the shutter again without advancing the film.

Automatic stops limit the extent of crank swing. With the increasing thickness of the film on the take-up

spool the crank swing decreases from $3/4$ of a turn in the beginning to just under $1/2$ turn at the end of the roll. Thus the film is always advanced exactly one full frame.

In addition to this, each swing of the crank automatically brings up the next number in the film counter window.

The positioning of the film so that the first frame is correctly placed also is accomplished automatically. After inserting the full film spool in the bottom chamber, the paper leader must be passed through the two feeler rollers and drawn up on to the empty take-up spool. The feeler rollers will allow uninterrupted passage of the thin backing paper. Only when the increased thickness (at the point where film joins paper) goes through the rollers, does the automatic tripping mechanism allow the counter to go into action. The crank continues briefly and then stops, firmly — the film has reached the position for exposure No. 1. The pressure of the rollers is released immediately after the passage of the film's beginning so that the rest of the roll will slip through freely.

After the twelfth exposure, the counter mechanism automatically disengages and the crank turns freely, permitting the complete winding up of the fully exposed film.





1

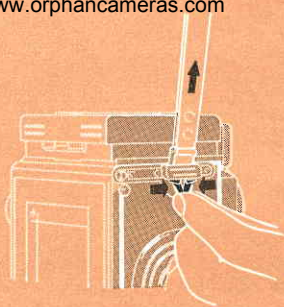

2



3

II. THE ROLLEIFLEX IN OPERATION

Neck Strap

The neck strap is adjustable and is secured by a unique quickfastening device; it serves also as the carrying case strap ①.

To Fasten: insert the retaining prongs at the ends of the strap into the camera's strap holders and snap closed ②.

To Release: press the retaining prongs together and remove strap.

Ever Ready Carrying Case

To Open: release snap on back and open cover forward ③. Before closing: set camera to focus on infinity.

Removing the Camera: detach the neck strap ② lift crank outward, spread the sides of the case slightly and pull camera forward ④.

Inserting the Camera: spread the two sides of the case slightly, guide the raised crank through opening from the inside and lower the camera backwards



4

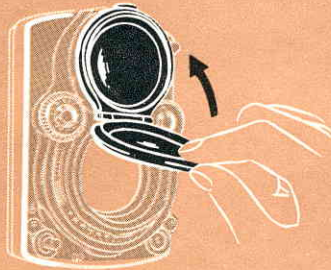

5



6

into the case; fasten the strap.

The film can be changed without completely disengaging the camera from the case. Merely unfasten the strap on the left (focusing) side of camera and refasten it to the camera only, on the inside of the case. Remove camera from case, leaving the case still attached through the strap fastening on the right side. A reverse procedure, taking care that crank handle protrudes through the opening will get the camera and case together again in shooting and carrying position.

Lens Cap

The upper part is attached in front of the viewing lens by bayonet mounting and the lower part through friction fit.

Removal of Lens Cap: lift the lower part by the tab at the lower edge and fold it against the upper part ⑤. Remove cap from the bayonet by turning it counter-clockwise $\frac{1}{4}$ of a turn ⑥.

Attaching Lens Cap: fit the folded cap into the bayonet of the viewing lens — hinge pointing to the right (focusing knob) — and fasten it with a $\frac{1}{4}$ turn clockwise. Fold down the lower part and snap into place.



1



2



3

Holding the Camera

Basic rule: camera hanging around the neck with taut strap and the camera held firmly by both hands. The right hand grasps the camera at the bottom, the index finger on the shutter release, the thumb supporting the uplifted crank (quick handling of the film transport: → p. 42). The left hand does the focusing ①. In this position diaphragm and shutter controls may be operated comfortably.

The camera is usually carried with a long strap over the shoulder. The strap remains taut and gives required steadiness when using ground glass ②. When using the magnifier, merely form a loop to shorten the strap, using the thumb of the right hand and adjusting camera to required position ③. This method of holding will aid materially in achieving the steadiness required for sharp pictures.



4

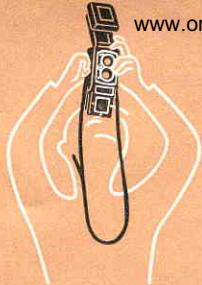

5



6



7

Caution: a wrong or uncomfortable "grip" may cause you to lift inadvertently the hanging top of the ever ready case.

To use the ever ready case when the camera is fitted with Rolleikin, remove the large leather disc to make room for the counter knob. Simply pry up the thin metal tabs.

Waist-level or eye-level positions for the camera are considered normal for most pictures. The extremely flexible Rollei, however, readily permits exposures at or near floor level, overhead, shooting straight up or down, and occasionally, surprise snaps "around the corner" ④-⑦. Thus the viewpoint may be altered at will, in order to obtain a variety of picture effects from different angles.



1



2

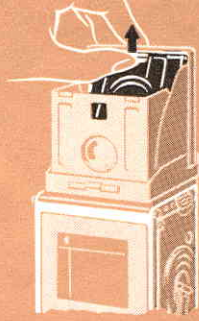

3

Focusing Hood

To Open: lift the rear edge of the focusing hood cover — Spring tension keeps it open ①.

To Close: pull back focusing hood ②.

Note: the focusing hood may be closed only with the magnifier in folded position.

The focusing hood may also be closed with the same hand movement that closes the ever ready case. The push-button at the rear of the focusing hood serves to hold the Rolleigrad lens or the Rolleikin ground glass screen mask.

Focusing Magnifier

To Raise: pull release lever in the open focusing hood upwards — the magnifier springs into position ③.

To Lower (before closing the focusing hood): push down magnifier flap until it snaps into position. Avoid touching the lens itself ④.

Use of the Magnifier: use the magnifier as close to the eye as possible.

The magnifier is interchangeable and may be replaced for the convenience of near or far sighted people. Strengths from minus three to plus three diopters are available.

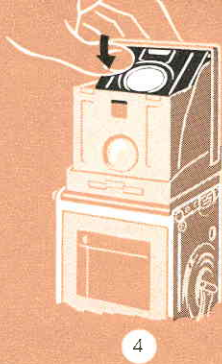

4

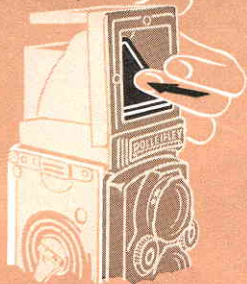

5



6

Direct View Finder

To Open (after raising the magnifier): push the direct view finder flap inwards until it snaps into place (5).

To Close: depress magnifier flap slightly — the direct view finder panel immediately returns to normal position (6).

The subject is viewed at eye-level through the direct view finder and focusing may be checked by means of the second (also interchangeable) magnifier.

The two pin sockets and small knob on the front of

the hood permit attachment of the Rolleikin direct view finder mask.

Changing Magnifier (if eyesight demands)

To Remove: pull back ring mount against retaining spring and lift out. To insert: put into position (back first), pull back against spring and snap down.

Rear Magnifier: to remove: push in slightly at top and lift out. To insert: slip magnifier (white dot uppermost) between retaining springs — push down until it snaps into place.

The sharpness of the ground glass is certain proof of the correct focusing of the camera.

Checking depth-of-field
→ page 26

The depth-of-field indicator on the focusing knob gives the exact extent of the depth-of-field.

The subject matter, of course, must determine whether you are to give first consideration to depth-of-field or to the choice of a suitable shutter speed.

Shutter speed adjustment
→ page 24

Shutter speed, of course, is chosen in accordance with requirements set by the motion of the subject (→ table page 25).

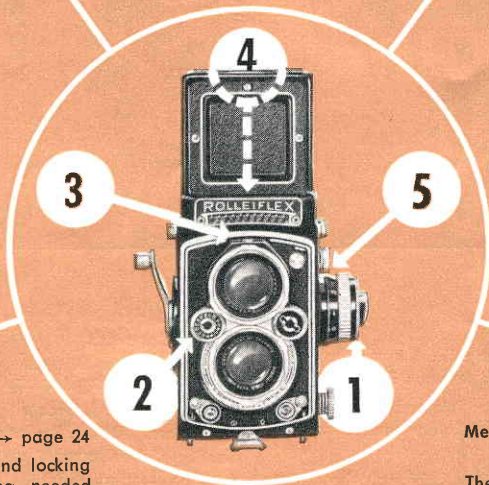

Adjusting light value → page 24

After setting the light value and locking the coupling mechanism, the needed combination of speed and diaphragm opening may be quickly chosen (within the permissible range) without further calculation.

Measuring exposure
→ page 19

The exposure meter supplies the correct light value for the speed of the film being used and to which the camera is subsequently set.

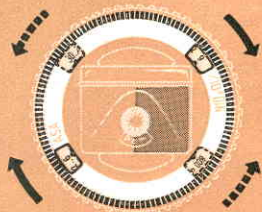

1



2



3

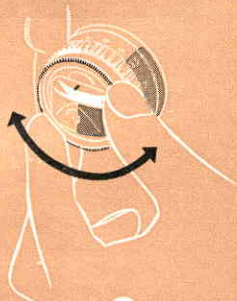

4

Exposure Meter

Adjusting to DIN/ASA Speed Ratings: turn the adjusting ring beyond the left or right stop ①, until the correct speed rating appears above the indicator mark. The dots are for the usual intermediate half-value DIN/ASA graduations.

Setting Sensitivity Range: in bright light move control (corner of nameplate) to upper stop so that red dot is covered — use forward light value window ②. In weak light, move control downward,

uncovering red dot — use red light value window ③. **Measuring for Light Value:** turn adjusting ring ④ until red and black indicators are exactly covered — read the indicated full or half-value in the appropriate light value window. If the indicators do not reach covering: change the range with the sensitivity control.

The exposure meter is ruggedly built and will withstand the strongest light in both ranges of measurement.

Two methods of measurement permit Rollei to master all light conditions:

Reflected light or object measurement

(Measuring the light reflected by the subject)

Advantage: Aiming camera in direction of subject is convenient. The meter covers the angle covered by the film so that it is very easy to point camera correctly, even when measuring light from specific objects or details.

Application: For black and white shots with well balanced differences in light (and shade) — for color shots with front lighting or with light partially from the side without visible shadows being included in picture.

For measuring details: When details are most important and if subject is unevenly lit.

To get reading: Aim at subject or detail with ground glass and read light value in this position ①.

Incident light measurement with Diffuser

(Measuring the light as it falls on the subject)

Advantage: Measuring incident light gives light value even in those cases where measurement of light from subject or detail cannot be achieved.

Application: For unbalanced lighting conditions when it is not possible to measure, separately, details important to the picture. Also for Rolleinar shots.

To get reading: Place diffuser in position over holding knobs on the photo-cell and aim in direction directly opposite to that to be used when shot is made. Example: from subject to intended camera position, or (in open air) towards a place with same light conditions. Read off light value ②.

The sun or other strong sources of light may adversely affect the reading even when located outside the immediate angle covered by the picture. Shade the cell in such cases at a distance of about 20 inches.

Reflected light or subject measurements represent the norm, the most used method, when light and shade are about evenly apportioned throughout the picture. The measured light value corresponds to the overall brightness of the subject.

Detail measurements become necessary when either very light or very dark areas prevail. In this case individual measurements are taken of the light and dark areas, and a mid-point light value is used. When advisable, this method can be varied to favor either the light or dark areas, whichever is more important. If the subject point of interest varies greatly in brightness from the rest of the picture, take the reading directly from this portion of the picture. Example: a person in front of a light wall or, conversely before a very dark entrance. In both cases, take reading directly from the person.

Additional Hints:

1. When measuring light from landscape, tilt camera forward to favor ground over sky.
2. Take close-up readings when the reading from the whole picture does not favor main part of subject. For instance, measure the face in a portrait.
3. When a subject cannot be approached conveniently for measuring, choose a nearby substitute object of same brightness. Example: animals in enclosures at a distance.

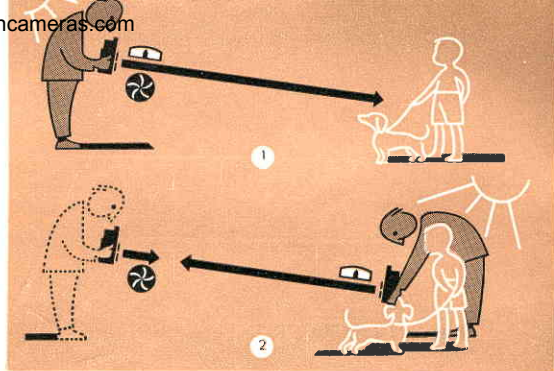

Incident light measurements (with diffuser) are often taken as substitutes for averaged detail measurements. A light value for average brightness of subject results. For subjects of great contrast, the measured light value should be varied (usually $\frac{1}{2}$ light value) according to whether the important part of the picture is lighter or darker than the average. Examples: Rolleinar shots of small objects as for instance, a light or brilliant blossom with dark background. Shots in shade with strong rays of sunshine. Objects with brilliant sky background. Against-the-light portraits. Pictures including bright reflections from snow, water, beach.

The light values with the adjustable speed-diaphragm combinations

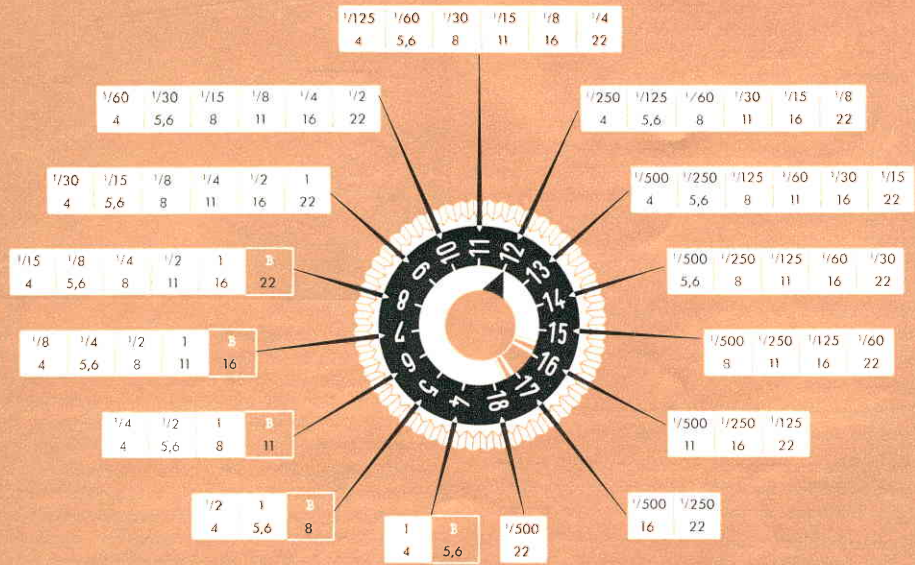

Note: Increasing the light value shortens the exposure; decreasing the value lengthens it.

Black and white films have great exposure latitude. Over-exposure can largely be offset by proper processing of the negative. Underexposure, however, results in loss of shadow detail. **A time-tried rule is to expose for the shadows, generally. If in doubt, it is better to err towards over rather than under-exposure.**

Color films have considerably less exposure latitude and strong lighting contrasts cannot be represented properly. Failure to observe this characteristic will result in changed color values. Overexposure, in the case of color transparency films will be indicated by pale, washed out colors. Under-exposure will cause the colors to appear excessively deep, although this is sometimes an advantage. Unless you are going after a special effect, adhere strictly to this rule: **Expose color film as exactly as possible and avoid excessive contrasts.**

Dark subjects tend to appear too deep in projection, even with good lighting and seemingly correct exposure. The opposite is true of light colored objects. Therefore, a second rule: **Expose dark subjects fully ($-1/2$ light value) and light subjects sparingly ($+1/2$ light value).**

	-1	2	3	4	5	6	7	8
f.22	250	125	60	30	15	8	4	2
16	125	60	30	15	8	4	2	1
11	60	30	15	8	4	2	1	
8	30	15	8	4	2	1		
5.6	15	8	4	2	1			
4	8	4	2	1				
3.5	6	3	1.5					
2.8	4	2	1					

sec

Light values and time exposures

Below light value 8, the shutter runs out of suitable speeds and time exposures must be used. With the shutter speed dial set at "B", appropriate exposure times and diaphragm openings may be chosen from the table on the back of the camera. The measured light value is located at the top, and the desired diaphragm opening at the left of the table. Where these columns cross the time of exposure, in seconds, will be found. Example: light value 4, diaphragm 11, 8 seconds. When the shutter is set at "B", change diaphragm opening by operating the control with the coupling button depressed. The light value scale on the speed control is inoperative in this range.

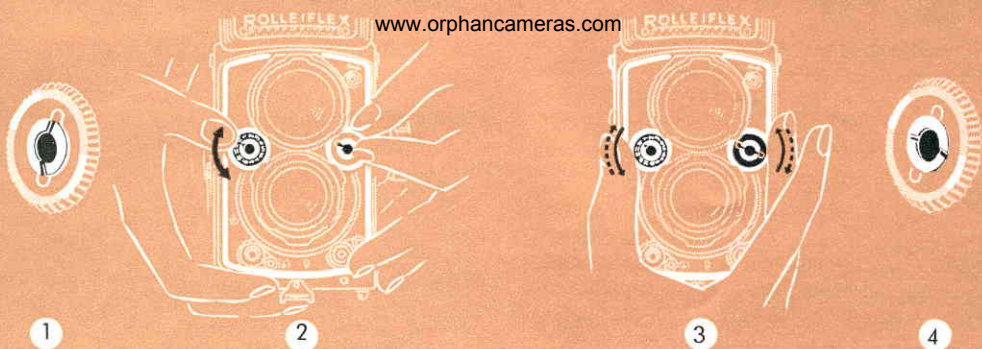

Light value (Shutter speed and diaphragm)

A. Normal case: Adjustment with speed-diaphragm coupling

To couple speed and diaphragm: Align the coupling button with the marks on the diaphragm control wheel ①.

Adjusting the light value: Temporarily decouple by depressing the button and set to desired full or half light value by turning speed control ②. If the light value cannot be reached before a stop is encountered, release the button, turn back the speed control and repeat the above operation.

Adjusting speed and diaphragm: Turn the speed control ring or, even better, turn both control wheels simultaneously in the same direction ③.

B. Special case: Adjustment without speed-diaphragm coupling

To uncouple: Set the coupling button so that it is diagonal to the marks on the control wheel ④.

Adjusting speed and diaphragm: Operate both control wheels independently. This manner of operation is usually used with flash, when the light value is not measured.

Speed of Moving Subjects and Shutter Speeds

		Miles per hour approximately																
		3 mph		6 mph		12 mph		30 mph		60 mph		120 mph						
Example:		Pedestrians		Runners Moving air		Bicycles Windy		Light Athletics Stormy Surf		Automobiles Railway Trains Racing		Motor Racing						
Distance (yards)	40		1/30	1/60	1/30	1/60	1/125	1/60	1/125	1/250	1/125	1/250	1/500	1/250	1/500	1/500	50	Distance (yards)
	15	1/30	1/60	1/125	1/60	1/125	1/250	1/125	1/250	1/500	1/250	1/500		1/500			25	
	8	1/60	1/125	1/250	1/125	1/250	1/500	1/250	1/500		1/500						12	
	4	1/125	1/250	1/500	1/250	1/500		1/500									6	

Moving Objects require short shutter speeds in order to be reproduced sharply. For this purpose the table contains computed minimum values, depending on the factors: speed, distance and direction.

Taking distance: the yard-column on the left stands for sufficient sharpness ($f/1400$), the yard-column on the right for increased sharpness ($f/2000$, → p. 28). In spite of these normally correct

figures, it is often possible in actual photography to use longer shutter speeds. This is because the eye interprets slight unsharpness as giving an added impression of speed.

Long arrow = direction movement.

A short arrow = taking direction (→ up to 10° , ↗ up to 30° and ↑ up to 90° to the direction of movement).

Hand-Held Pictures:					Tripod Pictures:					
Fast Speeds					Slow Speeds					Time Exposure
1/500	1/250	1/125	1/60	1/30	1/15	1/8	1/4	1/2	1 sec	B

Shutter Speed

The shutter speed chosen must be suited to the speed of motion of the subject (→ page 25). The Synchro-Compur shutter can be adjusted to the above designated speeds. Distinct click stops will be felt as each speed is reached and in-between speeds cannot be used. 1/60th sec. is the most commonly used speed, minimizing camera movement nicely. Shutter speeds longer than 1/30th sec. are not generally safe, except with a tripod. The figures indicating speed appear in the peep window in red and represent fractions of seconds; for example 30 = 1/30 sec. The green letter "B" setting permits longer time exposures. When using any combination of speed and diaphragm the setting of the speed must appear exactly in the center of the peep window.

Diaphragm – Sharpness – Depth of Field

The diaphragm opening values or figures appear in the peep window as black digits. The mark to one side of f : 3.5 indicates f : 4. Depending on how set, either the full or half-stop values appear in the peep window. F : 3.5 represents an intermediate stop between f : 2.8 and f : 4 in the international scale.

The diaphragm, amongst other things, regulates depth of field. Best sharp focusing technique requires that the area of sharpest focus be used to bracket the principal object in the picture. Of course, sufficient definition should also be present both before and behind the point of focus. The zone of this depth of field sharpness can be artfully enlarged. It is increased both by closing down the diaphragm and taking the picture from a greater distance.

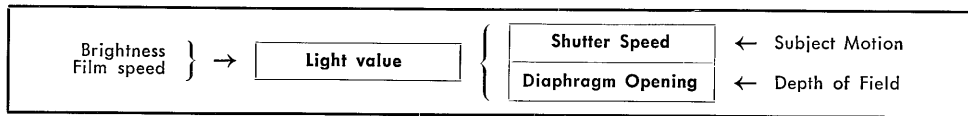

If the subject has an extended depth (for example, landscape with foreground), you must either change the speed-diaphragm combination to one with a smaller opening, or move back with the camera.

The range of the depth of field covered by any given setting is shown by the white band adjacent to the distance scale. The indicator is coupled to, and changes with, the diaphragm.

1. Example: Focusing on 15 ft with diaphragm at $f: 11$ provides a depth of field from approximately 10 to 30 ft. Focusing on 15 ft with diaphragm at 22 provides, on the other hand, an increased depth of field from 8 ft. to ∞ .

Very small diaphragm openings usually require excessively long exposure times so that some compromise is sometimes necessary:

2. Example: The subject requires a sharpness range from 7 to 10 ft (both figures may be ascertained exactly by focusing separately on the two points which bracket the subject). Solution: focus on the midpoint between the two distance figures and change the diaphragm so that the white band reaches both figures. In this way you will have selected the most favorable stop, in this instance $f: 8$.

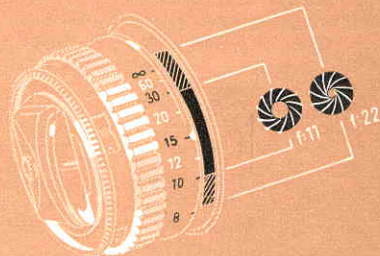

1

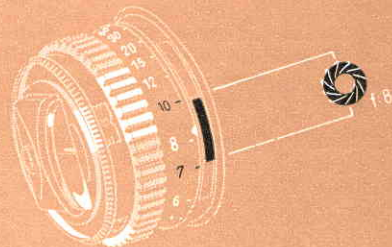

2

The Depth of Field Table

Since the sharp zone in the picture does not end abruptly, but gradually changes to something less sharp, it is generally sufficient to read the depth of field in round figures. With this in mind the scale on the focusing knob has been calibrated for quick and practical use.

If exact figures are desired, these may be found in the table on page 29.

For normal use the upper of the double row of diaphragm figures is used as in the case when an enlargement is to be made later from the entire $2\frac{1}{4} \times 2\frac{1}{4}$ negative. (These diaphragm openings are based on a circle of confusion of $1/1400$ of the focal length.)

On the other hand if enlargements are to be made from a small portion of the negative (or Rolleikin negatives), it is advisable to go by the lower row of diaphragm openings (circle of confusion = $f/2000$).

Explanation: the degree of sharpness required from a negative is exclusively dependent on the magnification of the prospective enlargement and its subsequent viewing distance.

In order to obtain a correct perspective impression at 10" (a comfortable viewing distance) a whole

Rollei negative would have to be enlarged $3.3 \times$ to $7\frac{1}{2} \times 7\frac{1}{2}$ ". Enlargements of this size, viewed at 10", determine the basis for the minimum acceptable sharpness. With this in mind the size of the circle of confusion is computed and the limits of the depth of field ascertained. Negatives made in this way will permit enlargements also to larger sizes, while still retaining the same impression of sharpness. This is because the viewing distance is always correspondingly increased.

With enlargements from portions of Rollei negatives or from Rolleikin negatives, the requirements with regard to sharpness are more critical. In this case depth of field is calculated using a smaller circle of confusion. In practical use the required depth is obtained through the use of a smaller diaphragm opening.

The effectiveness of the scale on the camera itself may be extended in the same manner merely by using the next smaller diaphragm opening than the one indicated for the desired zone.

If enlargements of very great size are to be made use a diaphragm opening two stops smaller than the one indicated.

Depth of Field Table (distances in feet)

Diaphragm		4	5.6	8	11	16	22	
Taking distance (in feet)	∞	141' - ∞	86' - ∞	61' - ∞	43' - ∞	31'4" - ∞	21'6" - ∞	15'7" - ∞
	60'	42' - 105'	35' - 198'	30'3" - ∞	25' - ∞	20'7" - ∞	15'10" - ∞	12'4" - ∞
	30'	24'9" - 38'	22'3" - 45'	20'2" - 59'	17'8" - 99'	15'4" - ∞	12'6" - ∞	10'3" - ∞
	20'	17'6" - 23'4"	16'3" - 26'	15'1" - 29'8"	13'8" - 37'	12'2" - 55'	10'4" - 290'	8'9" - ∞
	15'	13'7" - 16'10"	12'9" - 18'2"	12'1" - 19'10"	11'2" - 23'	10' - 29'8"	8'10" - 50'	7'8" - 350'
	12'	11'1" - 13'2"	10'6" - 13'11"	10' - 14'8"	9'5" - 16'8"	8'8" - 19'6"	7'8" - 27'1"	6'10" - 52'
	10'	9'4" - 10'10"	9' - 11'5"	8'7" - 12'1"	8'2" - 13'2"	7'7" - 14'10"	6'10" - 19'	6'1" - 27'5"
	8'	7'7" - 8'6"	7'5" - 8'10"	7'2" - 9'2"	6'10" - 9'9"	6'6" - 10'7"	6' - 12'5"	5'5" - 15'8"
	7'	6'8" - 7'4"	6'6" - 7'7"	6'5" - 7'10"	6'1" - 8'3"	5'8" - 8'10"	5'5" - 10'1"	4'12" - 12'1"
	6'	5'9" - 6'3"	5'8" - 6'5"	5'6" - 6'7"	5'4" - 6'11"	5'2" - 7'4"	4'9 ¹ / ₂ " - 8'1"	4'5 ¹ / ₂ " - 9'4"
	5'	4'10 ¹ / ₈ " - 5'2"	4'9" - 5'3"	4'7 ⁷ / ₈ " - 5'5"	4'6 ³ / ₈ " - 5'7"	4'4 ¹ / ₂ " - 5'10"	4'1 ⁵ / ₈ " - 6'4"	3'10 ³ / ₄ " - 7'1"
	4'	3'10 ³ / ₄ " - 4'1 ¹ / ₄ "	3'10 ¹ / ₈ " - 4'2"	3'9 ³ / ₈ " - 4'2 ⁷ / ₈ "	3'8 ³ / ₈ " - 4'4 ¹ / ₄ "	3'7 ¹ / ₄ " - 4'6"	3'5 ³ / ₈ " - 4'5 ³ / ₈ "	3'3 ³ / ₈ " - 5'2"
	3,5'	3'5 ¹ / ₈ " - 3'6 ⁷ / ₈ "	3'4 ⁵ / ₈ " - 3'7 ¹ / ₂ "	3'4" - 3'8 ¹ / ₈ "	3'3 ¹ / ₄ " - 3'9 ¹ / ₈ "	3'2 ³ / ₈ " - 3'10 ¹ / ₂ "	3'1" - 4'7 ¹ / ₈ "	2'11 ³ / ₈ " - 4'4 ¹ / ₈ "
	3'	2'11 ³ / ₈ " - 3'5 ⁵ / ₈ "	2'11" - 3'1"	2'10 ¹ / ₂ " - 3'1 ¹ / ₂ "	2'10" - 3'2 ¹ / ₄ "	2'9 ³ / ₈ " - 3'3 ¹ / ₈ "	2'8 ¹ / ₄ " - 3'4 ³ / ₄ "	2'7 ¹ / ₈ " - 3'6 ⁷ / ₈ "
Diaphragm	3.5	5.6	8	11	16	22		

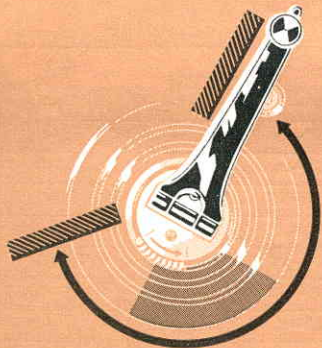

1



2

Shutter tensioning

Tensioning together with film advance is automatic through crank action ① (→ p. 40).

Tensioning without film advance — possible only with roll-film loaded camera — for intentional double or multiple exposures: move release ring at base of crank in direction of arrow and then turn crank through one complete backward revolution until it stops ②.

Tensioning with Rolleikin: automatic through crank action. Double exposures not possible.

Tensioning with Plate Adapter: swing crank normally, through 180°, and back to stop. Repeated tensioning for multiple exposures possible.

Releasing Shutter

Instantaneous exposures: with release guard in lowered position (↓), press release button gently until it stops ③a).

Time exposures: set shutter to "B", unlock release button (↓), press and hold for duration of exposure. To reduce possibility of camera movement, use cable release.

Long Time exposures: set shutter to "B", depress release slightly (not enough to open shutter) and swing guard to lock it in this position ↓ ③b). Exposure: press release completely ③c) and terminate by swinging release guard downward (↓) ③d).

Self-Timer

If the photographer himself wants to appear in the picture, the self-timer is employed instead of the shutter release button. It is cocked automatically by crank action (and is always ready for use). With the exception of B all shutter speeds from 1 to 1/500 sec. may be used. The action of the self-timer allows the photographer approximately 10 seconds before the shutter opens for the previously selected exposure time.

If the shutter has just been released by hand it is perhaps needless to say that the crank must be wound before either a self-timed or any other kind of picture can be taken.

To Release the Self-Timer: push the self-timer release button in the direction of the arrow (4).

The shutter and self-timer may be left cocked even when the camera is laid away for short periods of time without weakening the power of the springs.

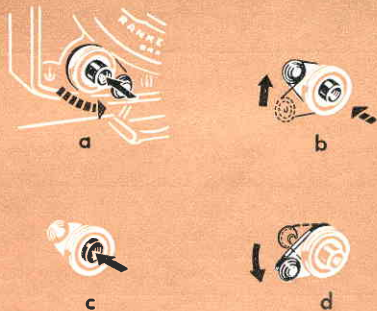

3





4

III. FLASHLIGHT TECHNIQUE

In modern flashlight technique the camera shutter takes over the task of firing the bulb electrically at the right moment. In this way instantaneous flash exposures are possible with a hand-held camera.

The Synchro-Compur shutter in the Rolleiflex is, for this purpose, equipped with electrical contact. The contact may be adjusted to the required delay of the flash lamps by means of the Synchro-lever:

When Synchro Lever is Set		
Proper contact * is	M-Contact	X-Contact
Source of flash	Flash bulbs and electric firing flash powder (capsule flash)	Electronic flash and some flash guns with short duration of flash
* Time of contact is	16.5 thousandths of a sec. before shutter is half opened	Immediately before full shutter opening

For safety reasons one pole of the contact is grounded to the camera body (isolation-test: 700 volts). All commercially available flash guns and electronic flash units may be used. Current-carrying capacity of the contact when several flash lamps are connected simultaneously: 10 ampères at 24 volts for a period up to a maximum of 1/15th sec.

The M contact stands for **full synchronization** for flash bulbs with a firing delay of 16.5 thousandths of a sec. The fastest shutter speeds up to 1/500 sec. can be used. Because of the delayed contact, the shutter always opens to catch the greatest volume of the light.

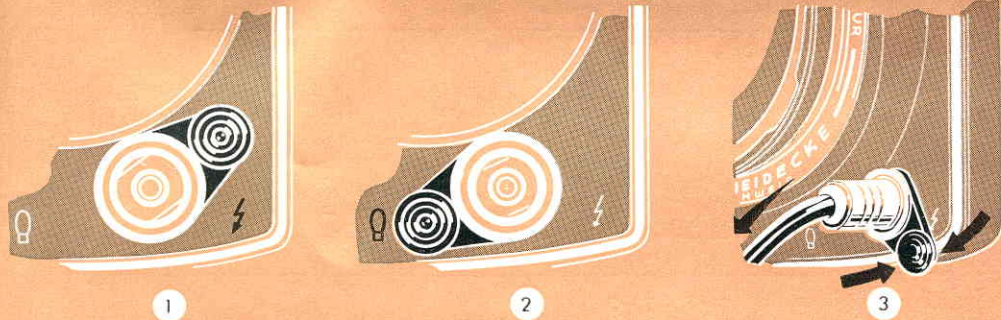

The selection of flash lamp-type depends on the light output required by the subject. Many makes are available in three groups (normal, medium and high light output). The selection is dependent on the taking conditions, especially as to whether a room of shallow or great depth is to be illuminated.

Selection of M-X lever position, applicable speed range and exposures can be learned from the instructions of the different flash light products. For



the best known makes the table on page 34 contains the necessary information and the permissible shutter speeds.

Connecting Flash Unit: push flash cord plug into the socket on the camera.

Setting for Flash: Swing the Synchro lever to X $\frac{1}{2}$ ① or M $\frac{1}{2}$ ②.

To Remove the Flash Cord: Swing the Synchro M-X lever partially to one side and pull out the plug ③.

Flash Contact and Permissible Shutter Speeds

FLASH LIGHT SOURCE		Contact	Shutter Speed: Fastest Recommended Slowest	Symbol
Make	Type			
I. Electronic Flash				
	Without Relay	X	1/500 1/250 1	
General Electric Westinghouse	SM (1/200)			
Sylvania	SF (1/200)	X	1/60 1/60 1	
West, Japan	SS (1/200)			
Osram	F0 (1/100) F1, F2 (1/50) XP, X0 (1/200)	X	1/50 1/30 1	
West, Japan	12 (1/100)			
Osram	S2	M	1/500 1/30 1	
Philips (Mazda)	S0, S1			
General Electric Westinghouse	PF 3 N, PF 14, PF 25, PF 56			
West, Japan	5, 11, 22	M	1/500 1/60 1	
Sylvania	0, 3, 5, 11, 22 Press 25, 40, 0, Bantam 8			
Philips (Mazda)	2	M	1/125 1/60 1	
General Electric Westinghouse	PF 110			
Sylvania	50	M	1/60 1/30 1	
General Electric Westinghouse	3			
West, Japan	6, 31	M	1/250 1/30 1	
Sylvania	FP 26, 2A			
III. Capsule Flash				
	Average	M	1/125 1/30 1	

Explanation of the Table

The **"Contact"** column indicates the correct setting of the M-X lever for each lamp type.

The **"Shutter Speed"** column shows the permissible speed range:

Center: the recommended shutter speed includes practically the entire light output of the flash lamp. This assures the maximum illumination as well as the smallest diaphragm (for greater depth of field). The following applies as a general rule:

Use the standard recommended speed together with the correct setting of the M-X lever for the lamp in use.

Left: the fastest speed indicates the limit to which the shutter may be set. For lively action or sports subjects, the faster speeds are employed.

Right: the exposure time may be increased to the slowest speed (1 second or even time exposures), if, in addition to the flash, it is desired to make use of existing light. In such cases the total amount

of light from all sources must be considered in choosing the diaphragm opening.

The Effective Exposure Time (as indicated in the table by means of **colored ink**) is not in each case identical to the shutter speed, but depends on the portion of the flash lamp light output utilized:

With X-Contact the duration of the flash itself is actually shorter than any of the permissible shutter speeds. Therefore, the duration of the flash (figure shown in parenthesis) is the effective appropriate exposure time and the diaphragm opening must be the same regardless of the shutter speed selected.

With M-Contact the shutter speeds, from "fastest" to "recommended" fall within the duration of the flash: they, therefore, represent the actual exposure time and if the shutter speed is increased, the diaphragm must be opened accordingly. Only when slower shutter speeds are employed is the fully utilized light output equal to the actual exposure time, and this is the same as the recommended speed.

The illustration should make the utilization of the available flash light still more obvious: the white symbols represent the flash, and their size, the utilized light at the shutter speed employed.



IV. LOADING AND FILM TRANSPORT

The Rolleiflex is loaded with $2\frac{1}{4} \times 3\frac{1}{2}$ roll-film 120 or B 118 (620 not usable) and delivers 12 exposures $2\frac{1}{4} \times 2\frac{1}{4}$.

The loading of the camera is confined to a few simple operations: open the back — insert the full film spool — thread the film — close the back. From now on the film transport follows automatically through crank action.

Back

To open: swing aside the back locking lever at the bottom of the camera ①, lift the clip ②, open back ③, using the clip as a handle.

To Close: with the flat of the hand push the back closed, fold down the clip and return locking lever to full forward position.

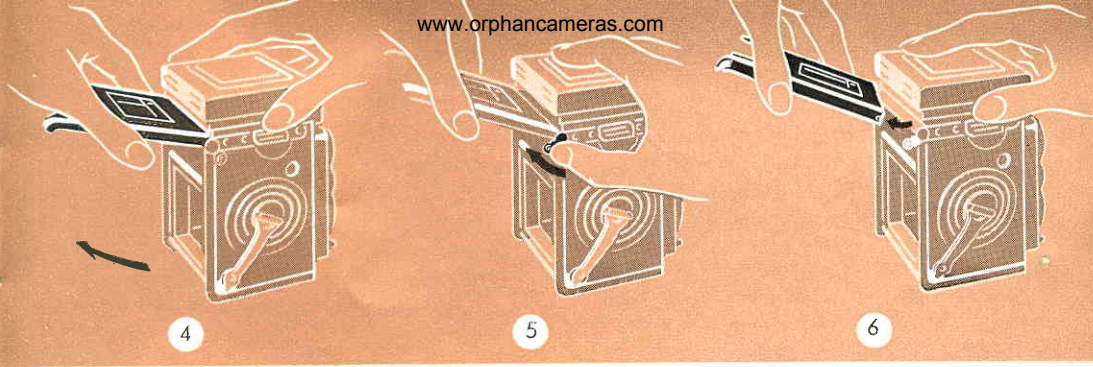

The back is generally removed only when replaced by the plate adapter.

To Remove: open back fully ④ and swing the locking lever on the right side back hinge (crank side) in the same direction until it stops ⑤. Slip back out of the opened hinge ⑥.

To Attach: insert detached back first into the left and then into the right hinge (with locking lever in the upper position).

Protect the open camera against prevailing dust

and dirt and clean it occasionally with a soft camel's hair brush!

Never change film in direct sunlight, utilize at least your own body's shadow!

The camera may be attached to a **tripod** by means of the threaded socket on the bottom. **Caution:** the length of the tripod screw must not exceed $3/16''$. If this is not possible, use "Rolleiflex" or other similar device and avoid damaging bottom of camera. For cameras with continental tripod sockets a reducing bushing is available.

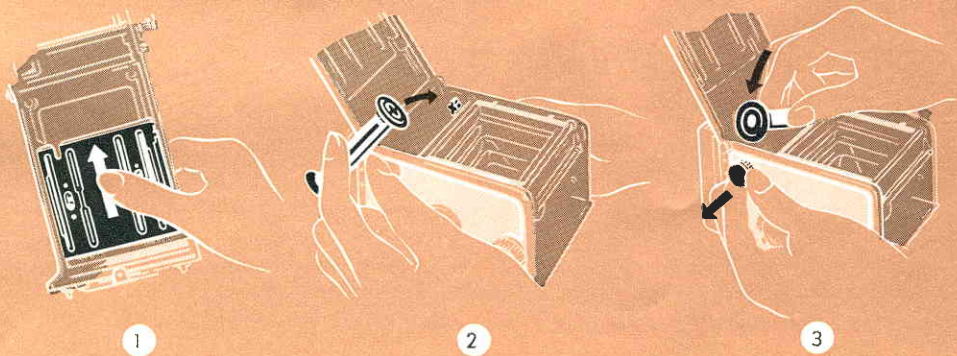

Film Pressure Plate Must be Positioned Correctly!

When roll-film is employed, the inscription $2\frac{1}{4} \times 2\frac{1}{4}$ " must be visible below the film pressure plate. When changing from 120 roll film to 35 mm film, or the reverse, an adjustment must be made according to the film type being used.

To adjust the film pressure plate ①: Press the plate against the back and push it up or down until it stops. When released it must spring forward completely into the normal plane!

Inserting the Film Spool

In the factory-new camera the empty spool (take-up spool) is already in position. After removal of the exposed film the just emptied spool becomes a take-up spool, and must be transferred to the upper spool-chamber. The end with the slot goes to the right engaging the winding key of the film transport mechanism ②.

Both spools are held on the left hand side by spool knobs. The bearing pins are withdrawn when changing spools by pulling out the knobs.

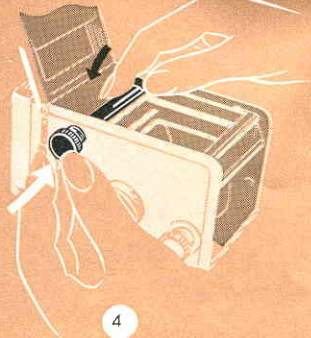

4



5

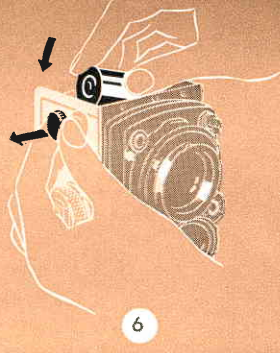

6

To Insert the Empty Spool: first fit the spool over the winding key on the right (crank side) and pull out the guide knob (3). Push the spool down on the left applying slight pressure, so that the knob may snap back into place fully (4). It is then necessary to turn the crank until the long slot in the empty spool comes uppermost (5).

Note: when using the adapter the empty 120 (or B 2)

spool is removed from the camera. However, it must be handily retained especially on trips, since otherwise a new roll-film cannot be loaded into the camera.

To Insert a Full Film Spool: in the same way as applies to the take-up spool (6). The pointed end of the backing paper must point in the direction of the take-up-spool chamber, so that the colored side of the backing paper remains on the outside.

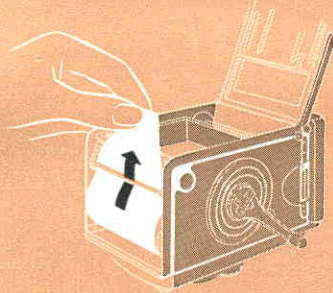

1

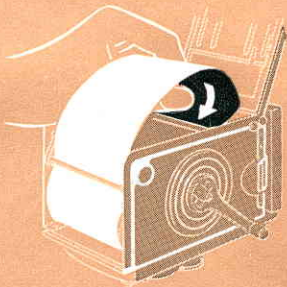

2

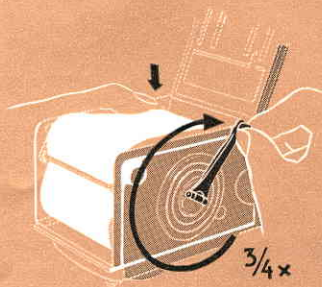

3

Threading the Film (Paper Leader)

After inserting the new film-spool tear the tape seal open and remove it.

1. Thread the beginning of the backing paper **through the rollers** of the film feeler mechanism (important!) and draw it up to the take-up spool, colored and printed side outwards ①.
2. Push the paper leader through the long slot of the take-up spool as far as it goes ②.

3. Tighten the backing paper by one spool turn (= approximately $\frac{3}{4}$ crank turn), making sure that the paper is wound up properly on the take-up spool ③ Close back (with the film pressure plate adjusted according to instructions!).

Film-Transport

The correct positioning of the film according to the first and following numbers of the exposure counter is accomplished exclusively by the crank. The correct operation of this is governed by stops:



4

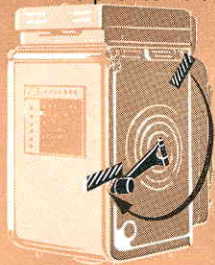

5

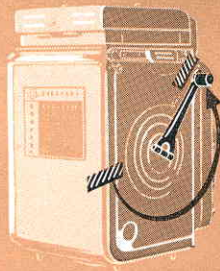

6

Swing out crank ④,
turn it until it stops with one continuous
swing ⑤ and then back again until the next
stop ⑥!

It is now locked, until the automatically cocked shutter
is released. The simple rule then reads:

If the crank can be turned, it must be
turned—once in each direction until it stops,
until it locks!

When advancing the film to exposure No. 1 some 4
to 5 complete crank turns are required. During
the last turn a slight resistance of the mechanism
must be overcome as the counter moves from 0 to 1.
If it should happen that the crank reaches starting
position when it stops, reverse direction one full
turn, so that it locks!

During continued film transport the amount of crank
travel decreases gradually to about a half turn.

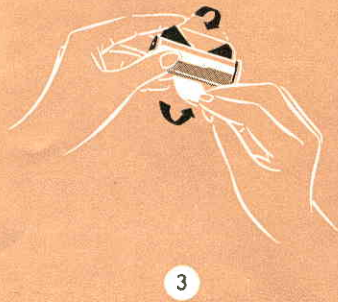
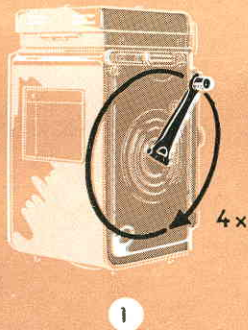

When making exposures in rapid succession it is unnecessary to fold down the crank each time. It remains locked in its starting position, ready for the next film advance, with a slight pressure of the thumb keeping it against its stop.

If longer intervals occur between exposures the question could arise: has the film already been advanced and the shutter cocked? The crank gives the answer immediately:

Only if locked is it "ready to shoot"!

To Remove the Film

After the 12th and last exposure four complete crank turns are enough to wind off the rest of the backing paper ①.

To Remove: open the back in the shade, pull out upper spool knob and remove the film from the same side ②. Fold under a good portion of the backing paper (for easier opening when developing) and seal ③. Put the exposed film back into the light-proof protective cover of the original package!



Speed of Photographic Emulsions

(Comparison values approximated)

ASA (BSI)	DIN	Weston	General-Electric	Scheiner (Europe)
6	9/10	5	7,5	20
8	10/10	6	9	21
10	11/10	8	12	22
12	12/10	10	15	23
16	13/10	12	18	24
20	14/10	16	24	25
25	15/10	20	30	26
32	16/10	24	36	27
40	17/10	32	48	28
50	18/10	40	60	29
64	19/10	50	75	30
80	20/10	64	100	31
100	21/10	80	120	32
125	22/10	100	150	—
160	23/10	125	200	—
200	24/10	160	250	—
250	25/10	200	300	—
320	26/10	250	400	—
400	27/10	320	500	—
500	28/10	400	600	—
650	29/10	500	800	—
800	30/10	650	900	—



Film Indicator

When loading with a new roll of film, adjust the film sensitivity setting of the exposure meter (→ page 19). The film reminder should also be set; markings for all film types are available, Ortho, Pan, Indoor color  and daylight color . Turn the knurled knob and watch the window

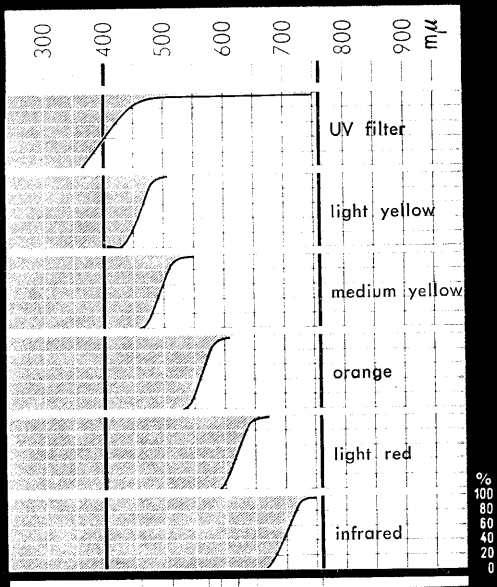

V. TIPS ON PICTURE-TAKING

Landscapes

Focusing for distant subjects including foreground. For maximum depth, set the infinity ∞ mark to the end of the depth of field band. Using diaphragm $f:11$, for instance, provides a depth of field sharpness extending from ∞ infinity to approximately 17 ft (5 meters).

Use of filters is important in black and white shots to separate and emphasize the tones of the dominant colors, such as those of the blue sky, green foliage and yellow grain fields. Specific changes in the atmospheric mood of the picture can also be effected.

1. Blue Sky with Clouds: yellow filters darken blue skies and thus improve the reproduction of clouds. The deeper the color of the filter, the stronger and more dramatic the effect. Blue snow shadows are also rendered truer to tone. The green filter tones down the sky, brightens foliage and darkens the occasionally too lightly rendered reds (with pan film) such as sun-tanned flesh and red tile roofs. For filtering the sky but not the landscape: the Rolleipol filter darkens the blue sky only by eliminating the polarized light.

2. Haze and Mist: the blue filter, useful for pictorial effects, increases hazy effect. The orange or red cut through and improve the clarity of distant views. The blue filter reduces contrast, the red or orange increase brilliance. Maximum penetration of light haze is obtained with infra-red film and infra-red filter (700 $m\mu$). Barely visible mountain chains are reproduced clearly. An odd effect with this combination is that green leaves are rendered almost white. Filters are of no use at all in really bad weather when there is a good deal of moisture in the air.

Seascapes, beach and high mountains: Use the ultra violet filter to cut out ultra violet rays and avoid washed out pictures.

Picture Composition Rules: distant views are generally better if foreground contains (for added depth impression) trees, people, animals, etc. Foliage is often used as a frame for the distant view. Focus should be sufficiently sharp in the foreground. Strong effects are created when deep shadows in the foreground are set against the lighter distance. Side lighting or even back lighting give the most impressive pictures.

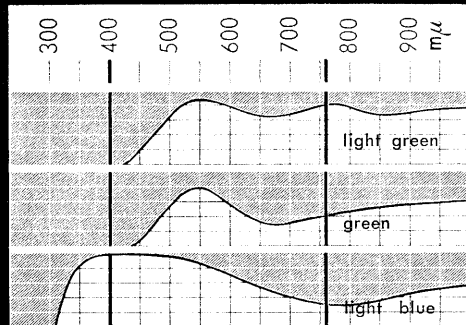



1:16 • 1/100 • sun + flash • filter light yellow

Portraits

Large heads: do not work closer than 40 inches to avoid possible perspective distortion. If necessary, enlarge from a smaller section or use Rolleikin. Focus on the eyes. Use quiet, neutral colored backgrounds and do not stop down too much (f : 5.6) so as to keep backgrounds from intruding. If possible, move subject away from background. Out of doors, try using sky as only background.

For portraits with panchromatic film in the open air, choose a soft lighting, preferably in the morning or late afternoon. Favor soft light, avoid deep shadows.

If necessary, light up the shadows with an aluminum foil — covered cardboard used as a reflector, or with flash. You can sometimes make effective use of light walls, clothing and snow as reflectors.

Simple, proven artificial light procedure: lamp No. 1 next to camera somewhat above head level, lamp No. 2 on the side to lighten shadows. For special effects, lamp No. 3 as overhead or back-light. Important: use lens hood and focusing extension hood for reducing extraneous light. Moisten lips (highlights!). To reduce sharpness and add "glamor": Rolleisoft (soft diffusion disc) 0 or 1 (stronger) over lens. Use larger diaphragm openings and backlight for sunny effects.

Children

Never use force, watch for interesting effects and expressions carefully. A clever assistant to divert children's attention from camera is often a valuable aid. Try close-up shots of children's expressions as they listen to favorite or exciting stories. Laughter, astonishment, pity and even an occasional yawn provide wonderful material for good shots or picture series. For close-up shots use same technique as for portraits. For children in motion, use snapshot technique outdoors and flash indoors. Low viewpoints and close-up effects are best.

Animals

Patience, quietness and familiarity with the animal and its peculiarities are great assets. Close-up pictures are most rewarding; use portrait technique. Make use of natural light effects such as back-lighting. Action pictures: use snapshot or sport technique (with flash, if needed). Rolleinaras are often helpful with small animals. Zoo: animal portraits — avoid bars or netting. Hint: netting often becomes invisible when lens nearly touches wire. — Fish in aquarium: use side and overhead lighting in otherwise darkened room. A good trick is to limit movement of fish within sharp zone by means of vertical glass plate in tank.





1:5.6 • 1/500 • filter yellow

Snapshots

Unexpected picture opportunities or rapidly changing subject distance make a simplified technique, based on depth of field zones, highly desirable. The following three settings have been found very effective:

1/125 sec.

Diaphragm opening f : 3

Short distances
approx.
9 to 18 ft

Medium distances
approx.
13 to 33 ft

Long distances
approx.
18 to 100 ft

12 ft

20 ft

30 ft

Shutter speeds and diaphragm openings do not often need changing in sunlight. Those suggested cover most contingencies. Thus instead of wasting time focusing when in a hurry, use one of the above settings. This snapshot technique is especially useful with the direct view finder. Variation of the values (see table page 29) makes this technique available for other depth of field zones. Example: diaphragm opening f : 11, focus at 30 ft, depth of field extends from 15 ft to ∞ for snapshots of scenes. Chief uses for this technique: groups in motion, street scenes, playing children, reportage, sports.

Sports

Sports pictures are generally most effective when the original rapid motion has been sufficiently "arrested" and the subject remains well defined. The fastest shutter speeds are essential, together with careful focusing. Sometimes pre-focusing on the spot where the action is to take place is possible. Do not overlook the possibilities of training sessions, since greater cooperation can often be had at such times. Snapshot technique is valuable for turf and ice shots and for any case when it would be difficult to guess exactly where to focus. Watch your shutter speeds and viewing angle. Shooting at right angle to the direction of the action requires a much faster speed than when the action is going in other directions (see table page 25). If the action is very fast or takes close to the camera, it is best to pan or follow with the camera. This results in a sharply rendered main object against a blurred background, thus increasing the impression of speed. There is often a fine moment for shooting when the action reaches a peak and stops momentarily, such as when a pole-vaulter "hits the top" before starting to come down again. With insufficient light or indoors use synchro-flash and $1/500$ th sec. The extremely short duration of electronic flash is highly desirable in some instances. Use the Rolleimeter and the direct view finder; do not overlook the advantages of the Rolleikin with its telephoto effect, maximum use of film area and greater film capacity.



1:5.6 · 1/500

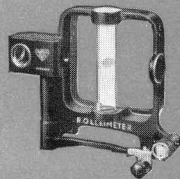

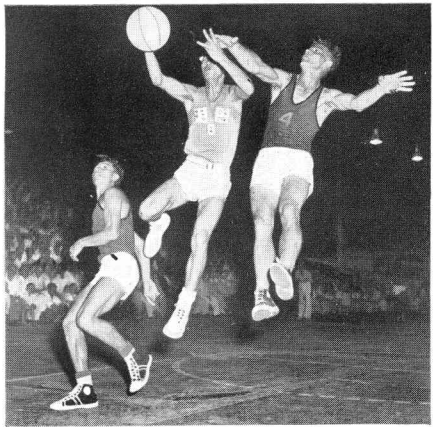

1:5.6 · 1/250 · *Electronic flash*

Flashlight

1. Use fresh batteries. Condenser or capacitor flash-guns are more consistent since lamp ignition is somewhat less dependent on battery power (Rolleiflash).
2. Be sure that the contacts of the battery and lamp sockets are clean. Handle flash cable with care, avoid kinking, otherwise there will be danger of short-circuit and premature flash ignition. — Note: the contact must not be connected to house current!
3. To light up long rooms or to achieve special illumination effects, one or two Rolleiflash comb. extension units may be connected to the Rolleiflash. Connecting cords adding up to a total length of 33 feet (66 feet with fresh battery) may be used. Always insert flash lamps in Rolleiflash first, then in extension units, to avoid premature firing. Unnecessary battery drain will be avoided by inserting lamps just before firing and ejecting immediately afterwards.
4. Blue flash lamps, like electronic flash, simulate daylight and are intended for use with daylight color film.
5. The power of flash illumination decreases according to the square of the distance: i. e., an object six feet away receives only one-fourth the light as an object

at three feet. Distance from flash to subject must therefore be carefully considered in selecting diaphragm opening. Lamp manufacturers supply easy to use guide numbers which are divided by the distance in feet to obtain the required diaphragm opening.

6. Flash as main light source: do not take weak room illumination into account, expose strictly according to flash output.

7. Flash as fill-in light: useful in brightening shadows whether due to insufficient illumination or to the fact that the picture is being taken "against-the-light", in full sunlight. The fill-in light must be kept at a lower intensity level than the main source of illumination, otherwise the strong flash will give an unnatural effect, not at all like daylight. Too strong a flash might even cause an apparent underexposure of the sky or the area not reached by the light. Electronic flash units are particularly well suited for use as fill-in lights when shooting color sports pictures. Use smaller lamps or keep them at greater distance.

8. Fully synchronized flash pictures are possible when using the self-timer through the entire shutter speed range from 1-500th sec. with M or X contact settings.



Sun



Sun + flash





Panorama Pictures

As special landscape photos: distant views covering a wide stretch of the horizon are easily possible with the panorama head. Any number of shots, from two to a complete circle (360°) ten may be taken to form a partial or complete panoramic view. Use a sturdy tripod and carefully level the camera by means of the spirit level provided in the panorama head. You may easily include yourself in one of the

pictures by means of the self-timer, thus adding interest in the form of a figure when none other is available. Changes in lighting must be considered in making the separate exposures. Fast moving clouds require that the succeeding pictures be made quickly in order to get easily matched joints. There is ample overlapping between each picture to make accurate cutting and joining easy. Of course, the prints should be well matched in tone and contrast as well.

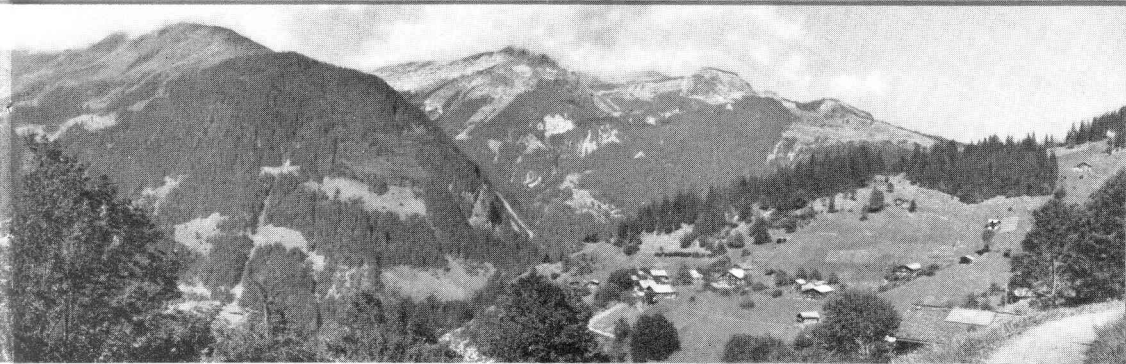

Multiple Exposures

The possibility of cocking the shutter without advancing the film (→ p. 30) permits double or multiple exposures. Here are a few trick possibilities: multiple portrait images of the same person. Pictures of "doubles". Penetrations: technical apparatuses in closed and open presentation.

Action studies with flash: moving machine parts in various working positions. Publicity: photographs super-imposed on text, combination photos.

Tone separations: multiple exposures with different filters. Time and growth studies: phototropism, crystallisation. When pictures are taken from the same position: completely steady tripod, immovable position of camera. Cable release! Dark, unlighted background simplifies photographing objects which are placed side by side (reduces the danger of interfering background). To facilitate composition, fashion paper masks for ground glass.

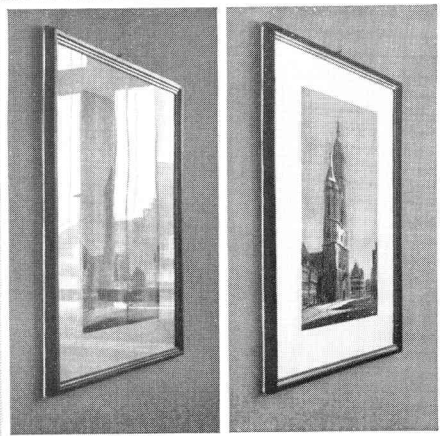

Rolleipol



Color Shots

Use extreme care in exposure when strong light contrasts prevail. In case of doubt take three shots, using the same shutter speed but varying the diaphragm a half-stop on each side of the estimated exposure. Make a note of the exposure data for future aid when facing similar conditions. The slightly longer exposure will result in lighter, more transparent colors in the slides, while the shorter exposure will result in deep color effects. You may of course set the meter for a lower film sensitivity when a longer exposure is desired and for a higher DIN/ASA rating when the opposite would be better. Critical workers will carry out such a test before going on vacation and then use a batch of film with the same emulsion number. Color films should be developed as soon as possible since storing exposed films adversely affects the colors. Color conversion filters can be used to correct for the deviations that occur in daylight or studio illumination. The Rolleipol filter is used to diminish reflections and to control the tone of the blue sky (page 44). Subjects with large plane areas are generally most pleasing; close-ups are most rewarding. Do not choose subjects displaying a conglomeration of harsh colors.

Color conversion filters

Modern color temperature meters will indicate the proper filter to use, taking into consideration the type of film and the prevailing light conditions. The most commonly encountered ranges of color temperature are also covered in the double

table A + B, pages 55 and 57. **Example:**

Ektachrome daylight film, overcast sky . . . which filter?

Solution: 1. Film — Look up film type (brand) being used.

(Ektachrome — daylight = upper part of page) follow the appropriate guide line to edge

of page (5500° Kelvin), slide page 55 to the left until guide

line A (5500° K) and B (page 57) meet. Hold pages in this position! **2. Lighting** —

Observe the type of lighting and its color temperature range (overcast = 6600—7000°).

3. Filter — Select the filter indicated opposite the correct temperature range (in this

case, R 2). Note that table B gives correction for light value (— 0,5) and the increase in

required exposure (1.5 times). The guide lines hereunder listed

require sliding page 55 somewhat further to the left.

	Film Type	Lighting	°Kelvin
Daylight	Agfacolor T Ansochrome Ektachrome Ferraniacolor Gevacolor Ilford Colour D Kodachrome Pakolor	Clear blue sky: in shadow	24000
		Deep shade, clouds	19000
		Overcast	16000
		Cloudless, sun to the side	14000
		Electronic flash	12000
		Blue flash bulbs Sun 9:00 A.M.-3:00 P.M.	11000
Artificial light	Ansochrome F Ektachrome F Kodachrome F	Sun before 9:00 A.M., after 3:00 P.M.	10000
		Clear, wire-filled flash bulbs	9000
		Photo flood lights SM and SF flash bulbs	8200
		Flood lights 100-500 W	7600
			7000
			6600
Artificial light	Agfacolor K Ektachrome B Gevacolor Pakolor		6200
			5800
			5500
			5200
			5000
			4700
Artificial light	Agfacolor K Ektachrome B Gevacolor Pakolor		4500
			4350
			4150
			4000
			3800
			3700
Artificial light	Agfacolor K Ektachrome B Gevacolor Pakolor		3550
			3400
			3300
			3200
			3100
			3000
Artificial light	Agfacolor K Ektachrome B Gevacolor Pakolor		2900
			2850

Rollei filters for black and white shots

Special compensation factors for light values are given when using filters, and these may be varied to suit type of film and lighting conditions.

Rollei Filter	Light value compensation		Application and effect
	Pan	Ortho	
Light yellow	-1	-1.5	Landscapes, snow, clouds. Renders yellow and green lighter, blue darker.
Medium yellow	-1.5	-2	
Light green	-1	-1.5	Landscapes, snow, clouds. Renders green lighter, red (complexion) and blue darker. For pan emulsions.
Green	-1.5	-2	
Orange	-1.5 to -3		Hazy distant views. Renders yellow-red lighter, blue darker, distant objects clearer.
Light red	-2 to -3.5		Hazy distant views. Renders red lighter, blue-green darker. Gives stronger effects than orange filter.
Light blue	-0.5	-0.5	Artificial light. Renders red darker. For ultra-pan emulsions.
UV	-0.5	-0.5	High altitudes above 6000 feet. Seascapes. Eliminates ultra-violet rays which reduce contrast.
Infra-red	Exposure depends on the type of emulsion		Special filter for infra-red emulsions. Transmits dark red above 700 $m\mu$ and infra-red.

Care of the Rolleiflex

A precision camera demands care in handling. Protect it against moisture, dust, sand, strong sunshine, hard blows or falls. First safeguard: the ever ready case. Proper camera protection is especially important on expeditions, in the tropics and for water sports. Use the metal ever ready case which is air-tight when closed and capable of floating. It provides sure protection against dust, humidity, splashes, wind-blown sand and blizzards. Carry camera around neck to minimize transportation shocks. Keep all parts clear and clean lenses with a soft camel's hair brush or doeskin. Although the mechanism is not unduly sensitive to cold, some condensation may form on the lenses when the camera is brought into a warm room from outside in cold weather. Do not wipe off — let moisture evaporate.

In Case of Damage to the Rolleiflex

The task of repairing major or minor damage is the special province of the expertly trained mechanic. Franke & Heidecke maintain their own special workshop in which all repairs are done with precision at nominal prices. Abroad, apply to photo dealers and factory representatives for full information.

The illustrations indicate filter density and filter combination.

R 16		-1,5	3x
R 13		-1,5	3x
R 11		-1	2x
R 7		-1	2x
R 5		-0,5	1,5x
R 2		-0,5	1,5x
B 2		-0,5	1,5x
B 5		-1	2x
B 7		-1,5	3x
B 11		-1,5	3x
B 13		-2	4x
B 16		-2,5	6x

Focal Length and Focusing-Range with Rolleinar Lenses

Rolleinar Lenses	-	1	2
Focal Length	75 mm	71 mm	68 mm
Focusing-Range (in inches)	$\infty - 35\frac{1}{2}$	$39\frac{1}{2} - 17\frac{9}{4}$	$19\frac{3}{4} - 12\frac{1}{8}$

Field-Size and Scale of Reproduction

Focused Distance	$31\frac{1}{2}$ in.	$19\frac{3}{4}$ in.	13 in.
Field-Size (in inches)	$2\frac{1}{4} \times 2\frac{1}{4}$	22×22	$13\frac{3}{4} \times 13\frac{3}{4}$
Rolleinar Size (in inches)	$9 \times 12\frac{1}{2}$	$5\frac{1}{2} \times 7\frac{7}{8}$	$3\frac{1}{2} \times 5\frac{1}{8}$
Scale of Reproduction approx.	1 : 10	1 : 6.3	1 : 3.9

Depth of Field with Rolleinar Lenses

Rolleinar	1	2	f/Stop
Focused Distance (in inches)	$31\frac{1}{2}$	$23\frac{1}{2}$	$19\frac{3}{4}$
Depth of Field (in inches)	from to	$22\frac{1}{2}$ $24\frac{3}{4}$	$18\frac{7}{8}$ $20\frac{1}{2}$
	from to	$28\frac{3}{4}$ $34\frac{1}{4}$	$18\frac{3}{4}$ $20\frac{7}{8}$
Depth of Field (in inches)	from to	$21\frac{5}{8}$ 26	$18\frac{1}{8}$ $21\frac{1}{4}$
	from to	$26\frac{3}{4}$ $38\frac{1}{4}$	$17\frac{3}{4}$ 22
Depth of Field (in inches)	from to	$25\frac{1}{4}$ $41\frac{3}{4}$	$16\frac{7}{8}$ $23\frac{1}{4}$
	from to	20 $28\frac{3}{4}$	$14\frac{5}{8}$ $17\frac{1}{4}$
Depth of Field (in inches)	from to	15 $16\frac{7}{8}$	8 11
	from to	5.6 8 11 16 22	$21\frac{1}{4} \times 21\frac{1}{4}$

Taking-distance measured from lens panel to object. Permissible circle of confusion in this special case (due to the large image and less need for enlarging) = $f/1000$. For increased sharpness further stopping down is required.

Rolleiflex 3.5 and the Practical Accessories*

Code:		Code:	
RIGAP	Rolleiflex 3.5/Planar with meter	GULEE	Leather Case only
ROGEX	Rolleiflex 3.5/Xenotar	GUSET	Leather Case containing: 1 Lens Hood and your choice of 2 Filters
BELME	Light meter elements for installation in Rolleiflex 3.5 with Xenotar	GUSOF	Leather Case only
BERIG	Ever Ready Case	GUSIX	Leather Case with 6 color conversion filters
BEMET	Metal Ever Ready Case	GUVBR	Leather Case only
FODRY	Desiccant Cartridge	GUSYN	Rolleiflex 3.5 Attachment
GUOBE	Lens Hood	BOXIN	Boxin Case for 1 Rolleiflex + 1 Rolleiflash comb.
GUIHE	Rolleiflex Filters:	CEKAB	Extension Cord for Flash-Attachment 10 ft.
GUIMI	Light yellow	FLACO	Extension Flashholder
GULIN	Medium yellow	TRIKA	Rolleiflash comb. with Connecting Cord 80 in.
GUEEN	Light green	BLIKA	Extension Cord for Rolleiflash comb. 10 ft.
GUORA	Green	FODIS	Flash Connecting Cord 32 in.
GUUBI	Orange	ROLKI	Rolleimeter 3.5, Optical Range Finder
GUBLA	Light red	FOSET	Rolleikin 3.5
GUFIR	Light blue	FOAPT	Plate adapter outfit (1 adapter back, 3 slides, 3 cut-film sheaths)
GUSKY	Infrared	FOPLA	Adapter Back
	Ultra violet filter	FOFAS	Slide
	Rolleiflex Filters:	FOFOD	Cut-Film Sheath
GURWO	R 2	FOFRI	Leather Case for 2 Slides
GURFU	R 5	FOFOD	Focusing Screen
GUREL	R 11	FOFOD	Slide
GUWOB	B 2	FOFOD	Rolleiflex Tripod Head
GUFUB	B 5	FOFOD	Panorama Head
GUELB	B 11	FOFOD	Rolleigridd Lens
GUTAR	Rolleipol	MARUG	Extension Hood
GUPUN	Rolleinar Lenses, set 1 (40-18 in.)		Rolleimarlin 3, undet-water housing
GUODO	Rolleinar Lenses, set 2 (20-12 in.)		
GUTNU	Rolleisoft 0		
GUTON	Rolleisoft 1		
GUCOM	Leather Case containing: 1 Lens Hood, 2 Sets of Rolleinar Lenses and your choice of 5 Filters		

* to fit Planar 3.5 and Xenotar 3.5 bayonet size II.

To avoid errors when ordering accessories please specify camera-number. Full information on the use of Rolleiflex accessories in the booklet "The Practical Accessories".