

This manual is for reference and historical purposes, all rights reserved.

This page is copyright© by M. Butkus, NJ.

This page may not be sold or distributed without the expressed permission of the producer

I have no connection with any camera company

On-line camera manual library

This is the full text and images from the manual. This may take 3 full minutes for the PDF file to download.

If you find this manual useful, how about a donation of \$3 to: M. Butkus, 29 Lake Ave., High Bridge, NJ 08829-1701 and send your e-mail address so I can thank you. Most other places would charge you \$7.50 for a electronic copy or \$18.00 for a hard to read Xerox copy.

This will allow me to continue to buy new manuals and pay their shipping costs.

It'll make you feel better, won't it?

**If you use Pay Pal or wish to use your credit card,
click on the secure site on my main page.**

PayPal Name Lynn@butkus.org



Rolleiflex

2.8C

IN PRACTICAL USE

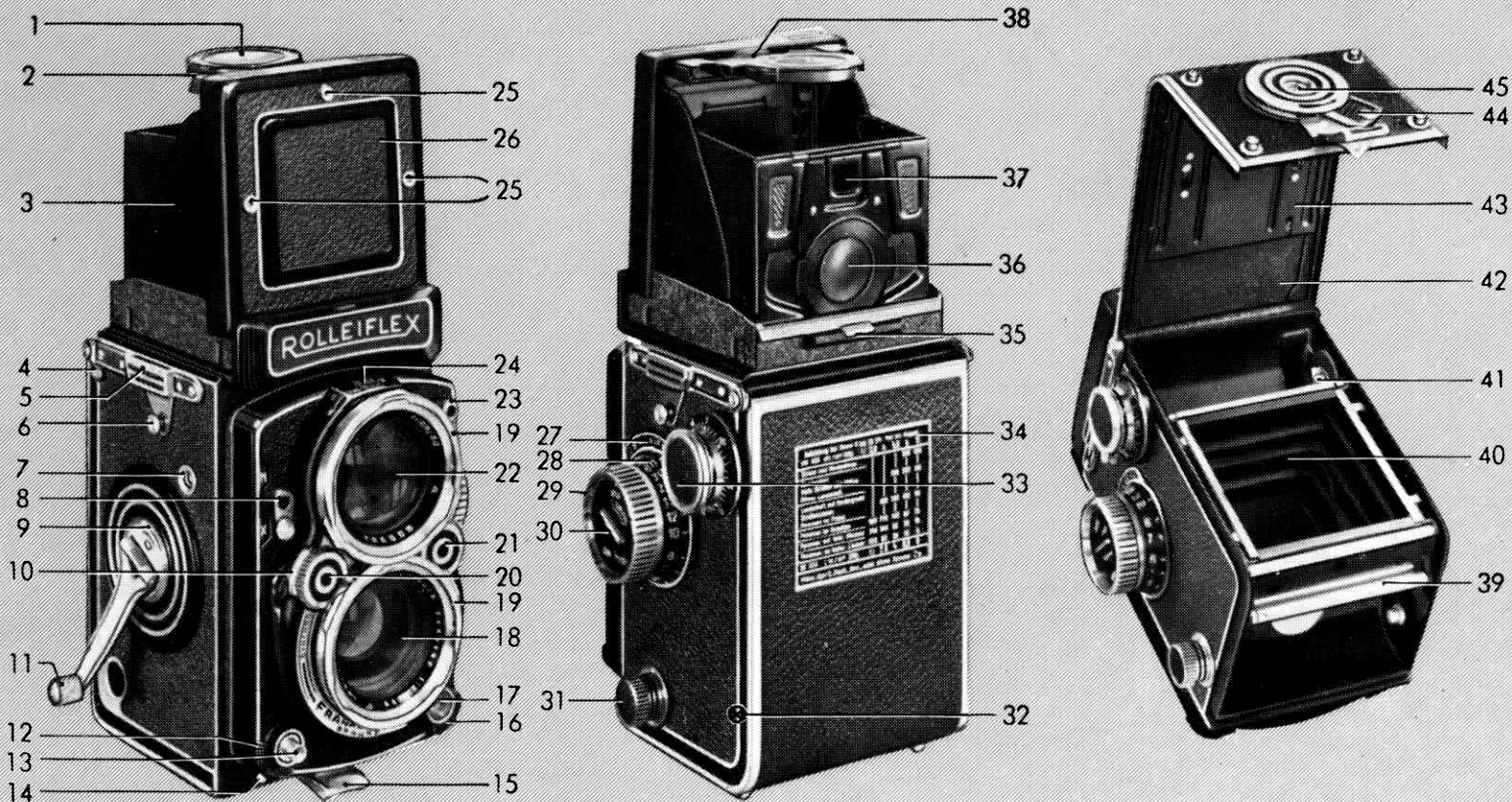

1 Focusing magnifier
 2 Magnifier flap
 3 Focusing hood

4 Locking clip for back hinge
 5 Eyelet slot for neck strap
 6 Neck strap button

7 Film frame counter window
 8 Synchro M-X lever

9 Crank release
 (to re-tension shutter
 for double exposures)

D. B. P. / S. G. D. G. / Pat. pend. / Brev. rich.

- | | | | |
|----|---|----|--|
| 10 | Arresting slide for shutter speed control | 30 | Adjustable reminder of film type and speed |
| 11 | Film advance and shutter tensioning crank | 31 | Film-spool knob (Rolleikin rewinding knob) |
| 12 | Shutter release guard | 32 | Focal or film plane (focusing distances measured from this line) |
| 13 | Shutter release with cable release socket | 33 | Take-up spool knob (Rolleikin counter knob) |
| 14 | Locating sockets for panorama head | 34 | Exposure table |
| 15 | Back lock clip | 35 | Retaining device for Rolleikin ground glass mask |
| 16 | Locking device for flash cord plug | 36 | Magnifier for eye-level focusing |
| 17 | Flash cable socket | 37 | Rear sight for direct view finder |
| 18 | Taking-lens | 38 | Magnifier lifting handle |
| 19 | Double bayonet mount for lens accessories and lens hood | 39 | Automatic film feeler mechanism rollers |
| 20 | Shutter speed control | 40 | Anti-reflection baffles |
| 21 | Diaphragm control | 41 | Winding key for take-up spool |
| 22 | Viewing-lens | 42 | Combination back for No. 120 (B II 8) and 35 mm film |
| 23 | Cocking lever for self-timer | 43 | Adjustable film pressure plate |
| 24 | Indicator window for diaphragm and shutter settings | 44 | Back locking lever |
| 25 | Pin-socket for Rolleikin direct view finder mask | 45 | Tripod socket |
| 26 | Direct view finder panel | | |
| 27 | Depth of field scale | | |
| 28 | Focusing scale | | |
| 29 | Focusing knob | | |

Equipped with the "high-efficiency" Schneider Xenotar f:2.8 lens the Rolleiflex 2.8 C offers a new and higher degree of photographic performance. To the already well known and distinctive conveniences of the Automatic Rolleiflex are now added new constructional features, designed to meet the most exacting professional demands. Truly, a new Rollei leader has arrived.

The following pages contain a fully detailed description, with illustrations, of the operation of the camera. A careful reading should serve to speed the new Rollei owner on his way to acquiring an easy proficiency in the practical use of his camera. Helpful rules and hints are also included.

We hope that this book will serve to help open new paths so that the many possibilities of the Rolleiflex 2.8 C may be easily and fully explored.

FRANKE & HEIDECHE
BRAUNSCHWEIG

www.butkus.us

THE QUICK BASIC PRINCIPLE

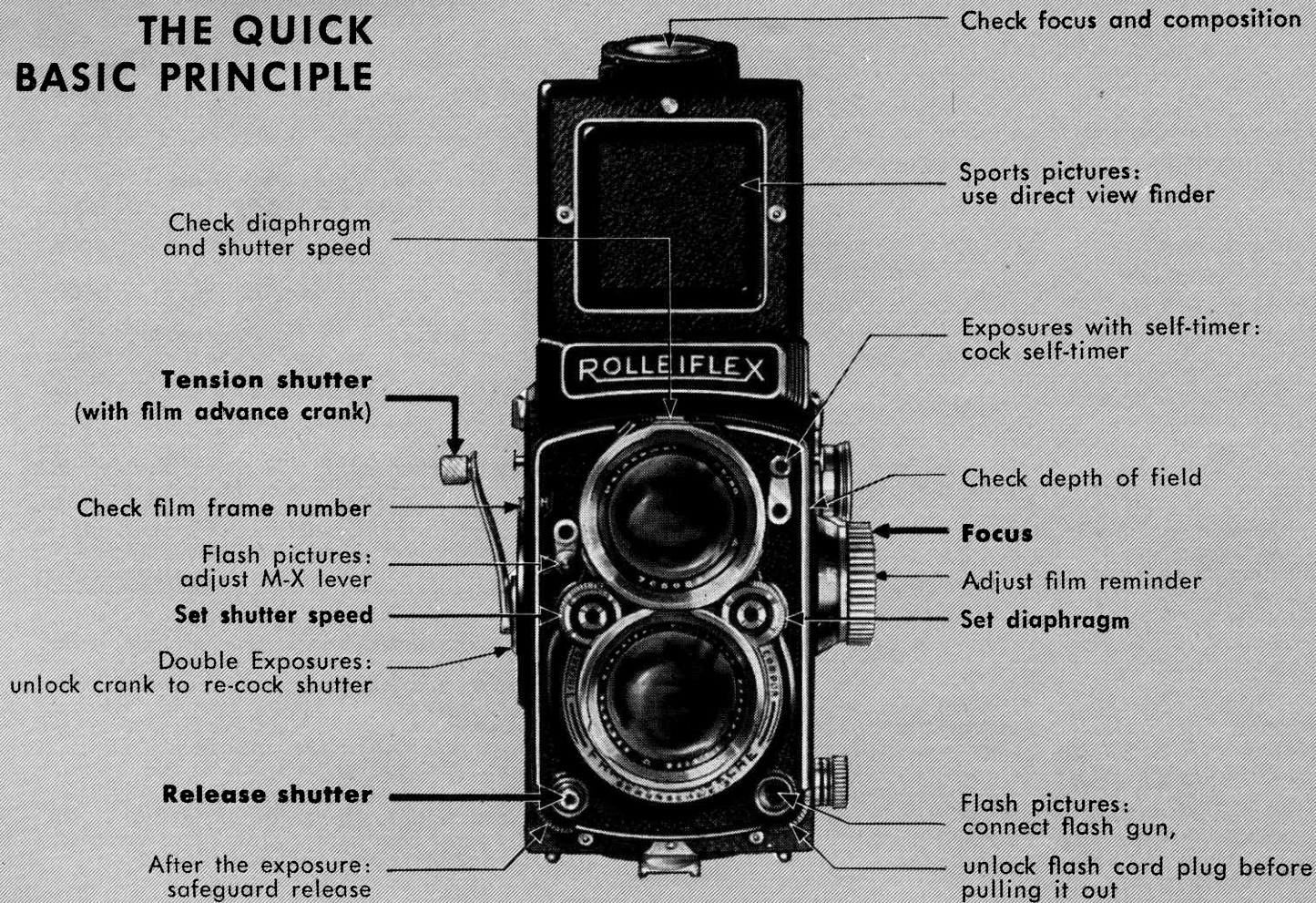

TO LOCATE THE MOST IMPORTANT PARAGRAPHS QUICKLY

Page:	Page:	Page:
6 I. A Brief Rolleiflex-Anatomy	28 III. Loading and Film Transport	49 Plants
10 The Automatic Film Transport Mechanism	28 Back	49 Color Pictures
12 II. Rolleiflex 2,8 C in Operation	30 Inserting the Film Spool	50 Multiple Exposures
12 Ever Ready Case	32 Thread the Film Leader	51 Panoramas
12 Neck Strap	32 Film Transport	51 Rolleigrid Lens
12 Lens Cap	35 IV. Flashlight Technique	51 Micro Photography
14 Holding the Camera	38 Flash Photography Tips	52 Care of Camera
16 Focusing Hood	40 V. Tips on Picture-Taking	52 In Case of Damage to the Camera
16 Focusing Magnifier	40 Landscapes	
17 Direct View Finder	42 Portraits	Tables:
18 Focusing	43 Children	21 Depth of Field
18 Diaphragm	43 Animals	23 Speed of Moving Objects and Shutter Speed
19 Depth of Field	44 Snapshots	36 Flash-contact and Shutter Speed
24 Shutter and Shutter Release	45 Sports	52 Speed of Emulsions
26 Self-Timer	46 Theatre and Music-Hall	53 Practical Accessories
26 Exposure	46 Night	54 Rollei Filters
27 Film Reminder	47 Copying	55 Rolleinars
	48 Reflecting Surfaces	

This Rolleiflex instruction book offers you the basic information necessary for the use of the camera. Practical matters of technique are adequately discussed, usually in the form of concise tips covering the most important phases of picture taking. Easy to use, highly informative tables are also included. It will therefore remain a source of information of permanent value to you.

Important: Before attempting to use or handle the camera we urge you to read carefully pages 12, 16, 24 and 28.

www.butkus.us

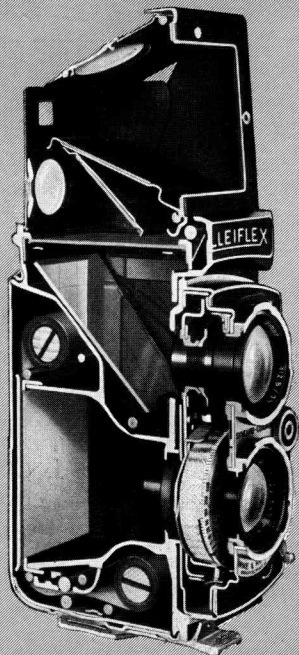

THE ROLLEI PRINCIPLE

I. A BRIEF ROLLEIFLEX-ANATOMY

The Automatic Rolleiflex is a camera characterized above all by two special design features: the rigid construction of the twin lens reflex and the automatic film transport mechanism. These technical advantages do not form merely a basis for very high performance but at the same time contribute materially to the simplicity and ease of use for which the Rollei is justly famous.

It takes but a glance at the construction of the camera to recognize the simple elements of its practical operation.

Construction of the Twin Lens Reflex

In the Rolleiflex two separate cameras are joined in a twin-camera with a common sturdy die-cast body: the bottom half is the

taking-camera, in which the film is exposed, and the upper half is the

viewing-camera, which is designed on the mirror-reflex principle. Its special task is to make the focusing visible on the ground glass and to supply a control image essentially similar to that of the prospective picture.

The image forming rays are transmitted by the fully open viewing lens, projected on to the ground glass screen via the mirror and the result is a right-side-up, but laterally reversed ground glass image, in the full size of the original picture. This viewing image is visible at all times and every detail of composition and framing may be watched even during exposure.

The ground glass screen is ruled with a number of vertical and horizontal lines making it possible to detect errors, such as lines which converge but should be parallel or a slanting horizon, in time to notice and correct them. It is easy to straighten or level the camera by means of the lines on the ground glass screen.

Above all, the ground glass screen provides the means for **focusing the camera**. This is accomplished by rotating the focusing knob. Both lenses, which are inflexibly coupled to each other by means of a sturdy common front plate, are thereby adjusted simultaneously: a sharp viewing image therefore guarantees an equally sharp picture. Since the Rolleiflex is equipped with a fast viewing lens and an optically prepared ground glass screen, the viewing image is extremely bright and clear and focusing can be done very critically.

The **focusing hood**, which is designed for one-hand operation is kept in both open and closed positions.

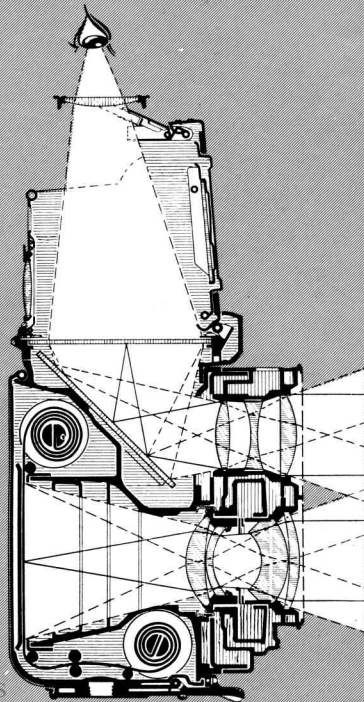

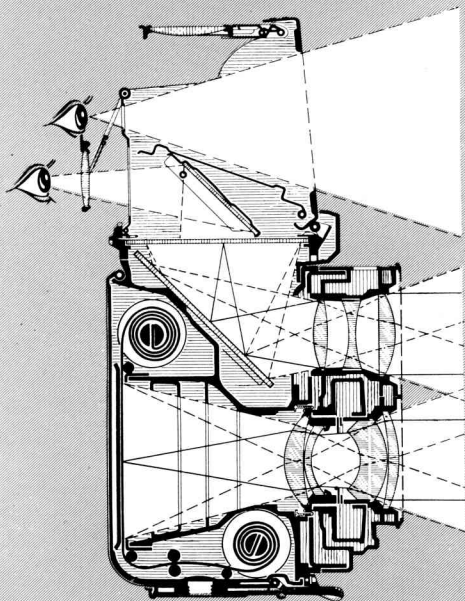

by spring tension. It is equipped with a swinging **magnifier**, adjustable to the individual eye-sight. It offers at approximately 2.5 times magnification of the entire ground glass image, a still more precise means for focusing the camera.

If the front panel of the focusing hood is pushed inward, it is transformed into a **direct view finder** through which the subject may be seen in natural size making it particularly easy to follow fast action. In this case it is still possible at all times to maintain control over focus: this is made possible by means of a second, adjustable magnifier in the back of the focusing hood, and a diagonally mounted mirror. A slight raising or lowering of the Rolleiflex is all that is required to alternate between the right-side-up open view in the direct finder, and the reversed center portion of the ground glass focusing image. The fact that the two finder openings are located so close together, enables quick framing of the subject after focusing. The usefulness of the open direct view finder is thereby enhanced for sports pictures.

Focusing the front lens panel throughout the range from ∞ (infinity) — 40 inches (distances measured from the focal or film plane to the subject) is accomplished by one full turn of the focusing knob.

The special design of the focusing mechanism (a cam-drive based on the principle of the archimedic spiral) insures uniform movement of the lens panel in both directions without play or backlash.

Tied in with the movement of the lenses is a simple sliding mechanism, located beneath the ground glass, providing completely automatic **parallax compensation**. Consequently, the final picture is always framed exactly as originally viewed on the ground glass screen. Similarly complete control is had even when using supplementary Rolleinar lenses for close-up work because of the Rolleipar which is built into the Heidosmat-Rolleinar.

Diaphragm openings and **shutter speeds** are regulated by small knurled wheels on the front panel while observing the scales in the single window at the top. Involuntary movement of the control wheels is prevented by the automatic arresting slide. Thus, all manipulations take place with the camera in operating position and are easily checked with but a single glance.

Since the two **lenses** are of identical focal length ($f=80$ mm) it follows that the image in both sections of the camera will always be critically focused on the same portion of the subject simultaneously.

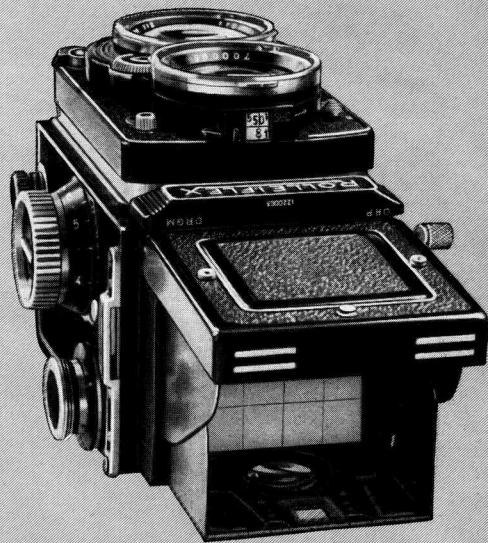

The Xenotar f:2.8 is a five glass construction with two cemented elements (modified Gauss-type) and features outstanding correction for black and white and color pictures, while the viewing-Heidosmat f:2.8 lens meets with the special requirements for critical ground glass screen focusing. Both lenses are treated with abrasion resistant coating. The bayonet receptacles circling the mounts are intended for attaching the lens hood and supplementary optical accessories, which in this way will be held in optically correct position and form a solid unit with the camera.

The removable **combination back** is attached to the camera by means of two hinges with automatic lock and at the bottom it contains the tripod socket and the safety back lock. Its adaptability for the two picture sizes $2\frac{1}{4} \times 2\frac{1}{4}$ ", and 24×36 mm is the result of the adjustable film pressure plate which can be set for 120 (B II 8)-film (with paper backing), or for 35 mm film (without paper backing) when used in conjunction with the Rolleikin 2 C attachment. In both cases a film channel is created with a width that corresponds to the thickness of the film being used. Thus the film can be properly held in the focal plane, and also can slide through without undue friction when advanced.

The Automatic Film Transport Mechanism

The constant readiness of the Rolleiflex, a natural result of its advantageous twin-lens design, is further enhanced by the automatic film transport mechanism. The quick acting **crank** coupled with an automatic gear mechanism performs five important functions with each pendulum swing:

1. Advances film to next frame
2. Advances film frame counter
3. Tensions the shutter
4. Releases shutter lock
5. Engages film lock.

The shutter release and film advance crank are locked and unlocked alternately, thereby offering full insurance against double exposures or skipped frames.

For intentional double exposures the crank must be unlocked at the crank base: Turning the crank a full turn to the left cocks the shutter again without advancing the film.

Automatic stops limit the extent of crank swing. With the increasing thickness of the film on the take-up spool the crank swing decreases from $\frac{3}{4}$ of a turn in the beginning to just under $\frac{1}{2}$ turn at the end

of the roll. Thus the film is always advanced exactly one full frame.

In addition to this, each swing of the crank automatically brings up the next number in the film counter window.

The positioning of the film so that the first frame is correctly placed also is accomplished automatically. After inserting the full film spool in the bottom chamber, the paper leader must be passed through the two feeler rollers and drawn up on to the empty take-up spool. The feeler rollers will allow uninterrupted passage of the thin backing paper. Only when the increased thickness (at the point where film joins paper) goes through the rollers, does the automatic tripping mechanism allow the counter to go into action. The crank continues briefly and then stops, firmly — the film has reached the position for exposure No. 1. The pressure of the rollers is released immediately after the passage of the film's beginning so that the rest of the roll will slip through freely.

After the twelfth exposure, the counter mechanism automatically disengages and the crank turns freely, permitting the complete winding up of the fully exposed film.

www.butkus.us

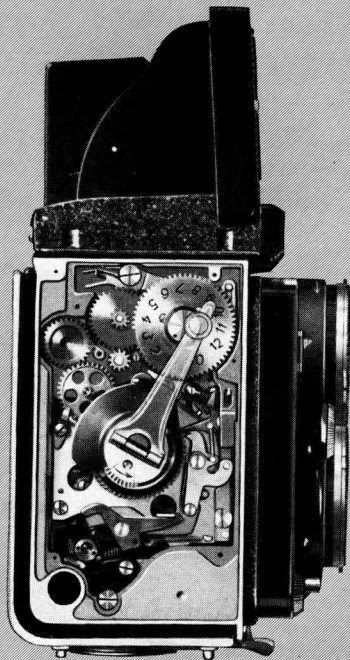

II. THE ROLLEIFLEX 2,8 C IN OPERATION

The Ever Ready Case

deserves mention here since it is so often used with the camera.

To Open: lift the top by grasping the snap catch buttons at the rear and fold forward and down (1).

To Close: pull the top over the camera and push down to engage the snaps. (Simultaneous folding of the focusing hood is also possible with this movement.) Always return focusing knob to infinity position since the extended front may otherwise interfere with closing the case.

To Remove Camera From Case: pull up the metal clips located at the top of the sides of the case (2). Lift the crank a little way from the case, spread the sides and lift the camera forward and out (3).

Putting the Camera in the Case: pull up the clips and spread the case apart; then slip the crank through the large opening from the inside and lower the camera backwards into the case. Push the clips down through the chrome plated strap holder slots.

The Neck Strap

In order to be able to carry the camera slung from the neck without an ever ready case, a special black leather strap is available.

How to fasten it: hook the metal loop of the leather strap on the strap holder button (4a), pull locking slide up and push it into the strap holder slot as far as it goes (4b).

The Lens Cap

is foldable. The upper part is attached in front of the viewing lens by bayonet mounting and the lower part through friction fit.

Removal of Lens Cap: lift the lower part by the tab at the lower edge and fold it against the upper part (5). Remove cap from the bayonet by turning it counter-clockwise $\frac{1}{4}$ of a turn (6).

Attaching Lens Cap: fit the folded cap into the bayonet of the viewing lens — hinge pointing to the right (focusing knob) — and fasten it with a $\frac{1}{4}$ turn clockwise. Fold down the lower part and snap into place.

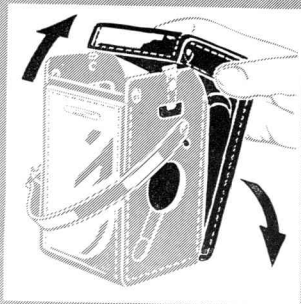

1

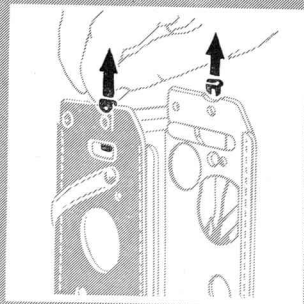

2



3

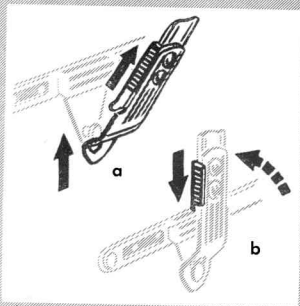

4

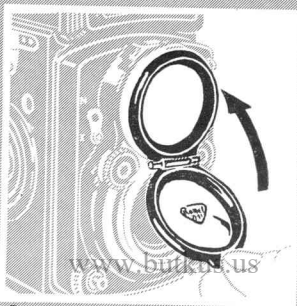

5

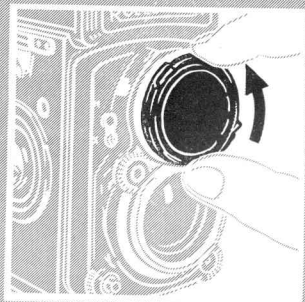

6



1

2

3

Holding the Camera

Basic rule: camera hanging around the neck with taut strap and the camera held firmly by both hands. The right hand grasps the camera at the bottom, the index finger on the shutter release, the thumb supporting the uplifted crank (quick handling of the film transport: p. 34). The left hand does the focus-

ing (1). In this position diaphragm and shutter controls may be operated comfortably with two fingers.

The Carrying Strap is adjusted to a comfortable length, so that the camera may be carried on the shoulder when not in use. In order that the shutter may be released with taut strap to avoid camera movement, loop the strap around the right hand, thus shortening it to achieve normal viewing

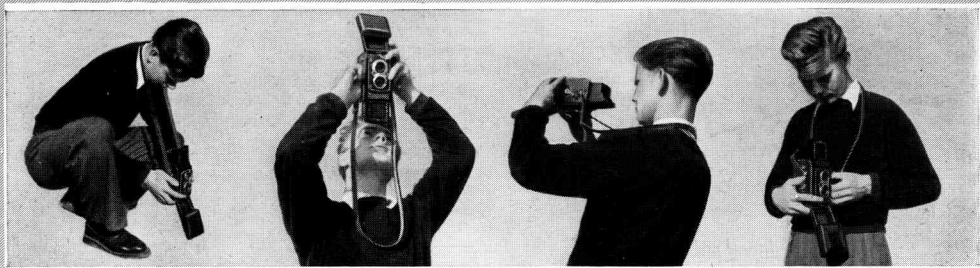

4

5

6

7

distance (2). Further shortening of the strap when using the magnifier can easily be effected by making use of the left hand in the same way (3).

Caution: a wrong or uncomfortable "grip" may cause you to lift inadvertently the hanging top of the eveready case.

In order to assure solid contact when working with a tripod, do not use the ever ready case.

Waist-level or eye-level positions for the camera are considered normal for most pictures. The extremely flexible Rolleiflex, however, readily permits exposures at or near floor level, overhead, shooting straight up or down, and occasionally, surprise snaps "around the corner". The illustrations (4—7) show a few possibilities for such pictures with the camera in different

www.brolia.com

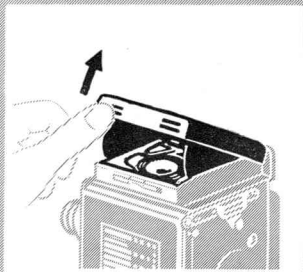

1



2

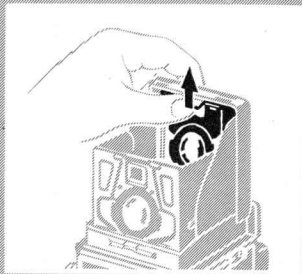

3

Focusing Hood

To Open: lift the rear edge of the focusing hood cover — Spring tension keeps it open (1).

To Close: pull back focusing hood (2).

The push-button at the rear of the focusing hood serves to hold the Rolleikin ground glass screen mask or the Rolleigrd lens.

Focusing Magnifier

To Raise: pull release lever in the open focusing hood upwards — the magnifier springs into position (3).

To Lower (before closing the focusing hood): push down magnifier flap by pressure on the side of the frame until it snaps into position (4).

Use of the Magnifier: use the magnifier as close to the eye as possible.

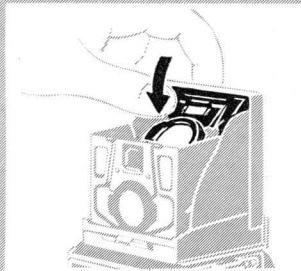

4

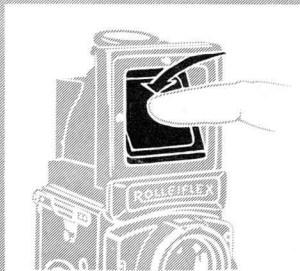

5

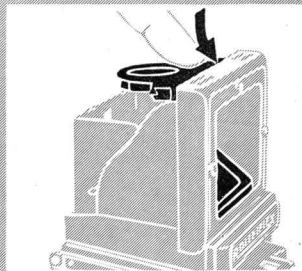

6

Direct View Finder

To Open (after raising the magnifier): push the direct view finder flap inwards until it snaps into place (5).

To Close: depress magnifier flap slightly — the direct view finder panel immediately returns to normal position (6).

The subject is viewed at eye-level through the direct view finder and focusing may be checked by means of the second magnifier.

Focusing Magnifiers for Added Convenience

Both magnifiers can also be focused by persons with faulty eye-sight, but not wearing glasses by tilting magnifiers out of their normal position: grasp magnifier at the sides, lift and focus critically on the ground glass screen lines.

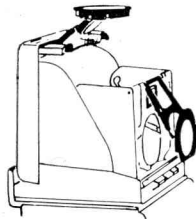

www.butkus.us

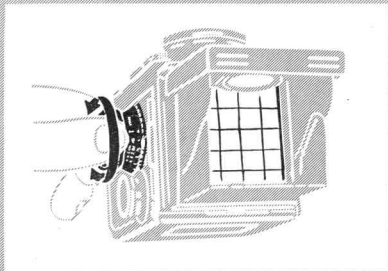

Focusing

Focus the Rolleiflex by turning the focusing knob, at the same time critically observing the sharpness of the ground glass screen image. The footage scale serves also to indicate the depth of field, a matter which need not concern you too much at first. The magnifier facilitates the most critical focusing. Important:

Focus so that the greatest degree of sharpness prevails at main subject distance.

The Diaphragm



The diaphragm controls the amount of light passing through the lens. It has a double effect:

Stopping down
 increases the depth of field and
 reduces the effective amount of light

Therefore the exposure must be increased correspondingly at smaller diaphragm openings. The following table gives the ratio of exposure at the different openings:

Diaphragm	2,8	4	5.6	8	11	16	22
Exposure	1	2	4	8	16	32	64

Notice that each succeeding smaller stop requires exactly double the exposure of the preceding one.

The diaphragm scale itself is easily seen, black figures, in the peep window above the viewing lens. The dot before f:22 indicates the position for f:16.

Setting the Diaphragm: turn the small knurled wheel while depressing the arresting slide simultaneously.

Depth of Field

Most picture subjects require that acceptable sharpness extend somewhat before and behind the exact distance focused on. Landscapes, for instance, require considerable "depth of field". Two factors influence the extent of the sharp zone: distance actually focused on and diaphragm opening.

In contrast to close-up focusing the sharp zone is many times greater when the lens is focused on long distance:

1. The depth of field increases with the taking distance.

In any case, however, the sharp zone of the picture may be increased considerably by stopping down the diaphragm:

2. The depth of field increases when stopping down.

As a practical rule the second alternative is preferable and only in emergency cases should the taking distance be increased because of loss in image size.

The extent of the depth of field at any distance may be read off on the focusing knob.

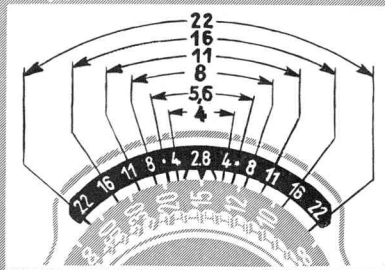

Depth of Field Scale

On and next to the focusing knob two scales are visible: the movable focusing scale with figures indicating feet and the fixed depth of field scale with the diaphragm values. The diaphragm stops 4—22 are arranged in pairs symmetrically on both sides of the central focusing point ▼. The 5,6 positions are indicated by dots.

The center of each footage figure indicates the correct setting for that distance.

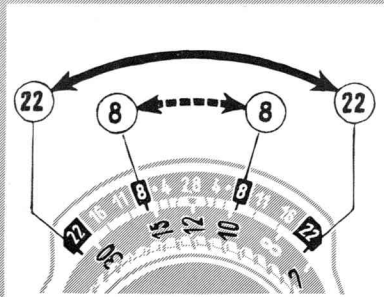

1

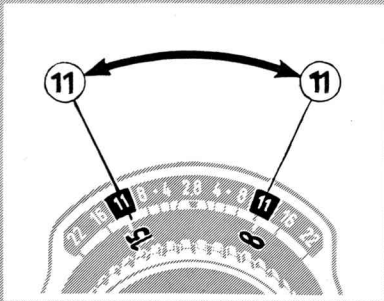

2

In Practice

After focusing, the near and far limits of the depth of field may be read off directly below the line marks indicating the diaphragm opening chosen.

The section of the footage scale bracketed between the marks representing the identical diaphragm opening indicates the exact zone of sharp focus.

1. Example: focusing to 12 ft with diaphragm opening 8 gives a depth of field 10 ft to 15 ft. Focusing to 12 ft with diaphragm opening f : 22 gives on the other hand a depth of field from 7,5 ft to 40 ft. approx. (Stopping down improves the depth of field!)

Considerable stopping down necessitates greatly increased exposure time. To obtain depth of field with the largest possible diaphragm opening, a different method of focusing must be employed:

2. Example: the subject requires sharpness from 8 ft to 15 ft. (Other distances, if unknown, can be read directly off the scale after focusing separately to the limits required.) Procedure: the focusing knob is turned until both footage values are located opposite identical diaphragm openings, and in this way the most favorable diaphragm opening is obtained, in this case f : 11.

Depth of Field Table (distance in feet)

Diaphragm		2.8	4	5.6	8	11	16	22	
Taking distance (in feet)	∞	187' 4" — ∞	131' 3" — ∞	93' 10" — ∞	65' 7" — ∞	47' 9" — ∞	32' 10" — ∞	23' 10" — ∞	16' 5" — ∞
	60'	43' 11" — 85' 4"	41' 4" — 109' 9"	36' 10" — 164' 4"	31' 8" — 690' 7"	26' 10" — ∞	21' 6" — ∞	17' 4 1/2" — ∞	13' 2" — ∞
	30'	25' 11" — 35' 7"	24' 6" — 38' 8"	22' 11" — 43' 9"	20' 11" — 55' 6"	18' 7 1/4" — 78' 7"	15' 11" — 312' 8"	13' 6 1/2" — ∞	10' 11" — ∞
	20'	18' 1 1/2" — 22' 4"	17' 5" — 23' 6"	16' 7" — 25' 3"	15' 5 1/4" — 28' 5 1/2"	14' 3" — 33' 10 1/2"	12' 7" — 49' 9 1/2"	11' 1" — 114' 11"	9' 2 1/2" — 197' 5"
	15'	13' 11" — 16' 3"	13' 6" — 16' 10 1/2"	12' 12" — 17' 9"	12' 3 1/2" — 19' 3 1/2"	11' 6 1/2" — 21' 7"	10' 5" — 27"	9' 4 1/2" — 38' 10"	8' 1/4" — 145' 7"
	12'	11' 4" — 12' 9 1/2"	11' 1/2" — 13' 2"	10' 8 1/2" — 13' 8"	10' 3" — 14' 6 1/2"	9' 8 1/4" — 15' 10"	8' 11" — 18' 7"	7' 10 3/4" — 23' 5"	7' 1 1/4" — 41' 5"
	10'	9' 6 1/4" — 10' 6 1/2"	9' 4" — 10' 9 1/4"	9' 1" — 11' 1"	8' 9" — 11' 8 1/2"	8' 4 1/4" — 12' 6"	7' 9 1/4" — 14' 1 1/4"	7' 2 1/8" — 16' 8 1/2"	6' 4 1/2" — 24' 3"
	8'	7' 8 1/2" — 8' 4"	7' 6 3/4" — 8' 5 3/4"	7' 5" — 8' 8 1/4"	7' 2 1/4" — 9' 1 1/4"	6' 11" — 9' 5 3/8"	6' 6 1/4" — 10' 4 1/2"	6' 1 1/4" — 11' 8 1/2"	5' 6 1/4" — 14' 11"
	7'	6' 9 1/4" — 7' 3"	6' 7 7/8" — 7' 4 3/8"	6' 6 5/8" — 7' 6 1/4"	6' 4 1/2" — 7' 9 1/4"	6' 2" — 8' 1 1/4"	5' 10 1/8" — 8' 8 7/8"	5' 6 1/8" — 9' 7 3/4"	5' 3/8" — 11' 8 1/2"
	6'	5' 10" — 6' 2 1/4"	5' 9 1/8" — 6' 3 1/8"	5' 8" — 6' 4 1/2"	5' 6 3/8" — 6' 6 1/2"	5' 4 5/8" — 6' 9 3/8"	5' 1 5/8" — 7' 2 1/2"	4' 10 3/8" — 7' 9 1/4"	4' 6 1/8" — 9' 1"
	5'	4' 10 5/8" — 5' 1 1/2"	4' 10" — 5' 2 1/8"	4' 9 1/4" — 5' 3"	4' 8 1/8" — 5' 4 3/8"	4' 6 7/8" — 5' 6 1/4"	4' 4 7/8" — 5' 9 5/8"	4' 2 5/8" — 6' 2 1/8"	3' 11 1/4" — 6' 11 1/8"
	4'	3' 11 1/8" — 4' 7 7/8"	3' 10 3/4" — 4' 1 1/4"	3' 10 1/4" — 4' 1 3/4"	3' 9 5/8" — 4' 2 5/8"	3' 8 3/4" — 4' 3 3/4"	3' 7 1/2" — 4' 5 5/8"	3' 6" — 4' 8 1/8"	3' 3 7/8" — 5' 1"
3.5'	3' 5 3/8" — 3' 6 3/4"	3' 5" — 3' 7"	3' 4 3/4" — 3' 7 3/8"	3' 4 1/4" — 3' 8"	3' 3 5/8" — 3' 8 3/4"	3' 2 5/8" — 3' 10 1/8"	3' 1 1/2" — 4'	2' 11 3/4" — 4' 3 3/8"	
Diaphragm		2.8	4	5.6	8	11	16	22	

Since the sharp zone in the picture does not end abruptly, but gradually changes to something less sharp, it is generally sufficient to read the depth of field in round figures. With this in mind the scale on the focusing knob has been calibrated for quick and practical use.

If exact figures are desired, these may be found in the table on page 21.

The Depth of Field Table

For normal use the upper of the double row of diaphragm figures is used as in the case when an enlargement is to be made later from the entire $2\frac{1}{4} \times 2\frac{1}{4}$ negative. (These diaphragm openings are based on a circle of confusion of $1/1400$ of the focal length.)

On the other hand if enlargements are to be made from a small portion of the negative (or Rolleikin negatives), it is advisable to go by the lower row of diaphragm openings (circle of confusion = $f/2000$).

Explanation: the degree of sharpness required from a negative is exclusively dependent on the magnification of the prospective enlargement and its subsequent viewing distance.

In order to obtain a correct perspective impression at 10" (a comfortable viewing distance) a whole Rollei negative would have to be enlarged $3.1 \times$ to $7\frac{1}{8} \times 7\frac{1}{8}$ ". Enlargements of this size, viewed at 10", determine the basis for the minimum acceptable sharpness. With this in mind the size of the circle of confusion is computed and the limits of the depth of field ascertained. Negatives made in this way will permit enlargements also to larger sizes, while still retaining the same impression of sharpness. This is because the viewing distance is always correspondingly increased.

With enlargements from portions of Rollei negatives or from Rolleikin negatives, the requirements with regard to sharpness are more critical. In this case depth of field is calculated using a smaller circle of confusion. In practical use the required depth is obtained through the use of a smaller diaphragm opening.

The effectiveness of the scale on the camera itself may be extended in the same manner merely by using the next smaller diaphragm opening than the one indicated for the desired zone.

If enlargements of very great size are to be made use a diaphragm opening two stops smaller than the one indicated.

Speed of Moving Subjects and Shutter Speeds

		Miles per hour approximately															
		3 mph		6 mph		12 mph		30 mph		60 mph		120 mph					
Example:		Pedestrians		Runners Moving air		Bicycles Windy		Light Athletics Stormy Surf		Automobiles Railway Trains Racing		Motor Racing					
Distance (yards)	40		1/25	1/50	1/25	1/50	1/100	1/50	1/100	1/250	1/100	1/250	1/500	1/250	1/500	1/500	50
	15	1/25	1/50	1/100	1/50	1/100	1/250	1/100	1/250	1/500	1/250	1/500		1/500			25
	8	1/50	1/100	1/250	1/100	1/250	1/500	1/250	1/500		1/500						12
	4	1/100	1/250	1/500	1/250	1/500		1/500									6

Moving Objects require short shutter speeds in order to be reproduced sharply. For this purpose the table contains accurately computed minimum values, depending on the factors: speed, distance and direction. Taking distance: the yard-column on the left stands for sufficient sharpness (f/1400), the yard-column on the right for increased sharpness (f/2000). In spite of these normally correct figures,

it is often possible in actual photography to use longer shutter speeds. This is because the eye interprets slight unsharpness as giving an added impression of speed.

Long arrow = direction movement.

A short arrow = taking direction (→ up to 10°, ↗ up to 30° and ↑ up to 90° to the direction of movement).

Tripod Pictures:					Hand-Held Pictures:				
Time Exposure	Slow Speeds				Fast Speeds				
B	1	1/2	1/5	1/10	1/25	1/50	1/100	1/250	1/500 sec.

Shutter and Shutter Release

The Synchro-Compur-shutter is a between-the-lens shutter and operates with the above mentioned speeds. 1/50th sec. stands as the most commonly used instantaneous shutter speed with little risk of camera movement. Shutter speeds longer than 1/25th sec. are in general possible only with a tripod. Avoiding unsharpness due to movement: see table p. 23.

The shutter speed values appear in the peep window as red figures — read them as denominators of the fraction values, i. e. 25 = 1/25th sec. Intermediate speeds may be set at any points between 1 sec. and 1/10th sec. and between 1/25th and 1/250th sec. Due to a supplementary spring, added resistance will be felt when setting to 1/500th sec. The shutter should be set to or changed from this highest speed before cocking by means of crank action.

The **shutter release** is safeguarded by an upward movement of the swinging release guard and unlocked by a downward movement. When the release button is pushed down the shutter opens only after overcoming a slight but distinct resistance. The depressed release button can also be locked in this position for long time exposures. — A **cable release** may be screwed into the release button and can be used whether the release is locked or not.

The camera may be attached to a tripod by means of the threaded socket on the bottom. **Caution:** the length of the tripod screw must not exceed 3/16". If longer, employ a washer or spacer to avoid damage to camera. For cameras with continental tripod sockets a reducing bushing is available.

1/500th sec. — set speed first — then cock shutter!

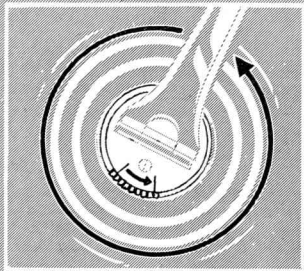

1

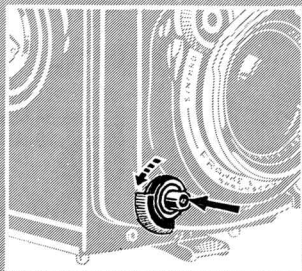

2

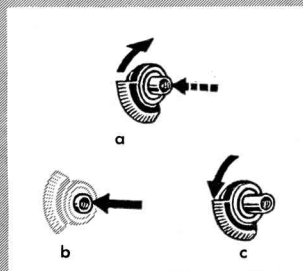

3

Setting the shutter speed: turn the small, knurled wheel while depressing the arresting slide simultaneously.

Cocking the shutter with the film transport: automatically through crank action (page 32).

Cocking without film transport (for double exposures, possible only when camera is loaded; if plate adapter is used: cock shutter in the usual way): turn release ring at crank base as indicated by arrow, then turn crank one complete left revolution until it stops (1).

Instantaneous Exposures: unlock release button and depress it gently until it stops (2).

Time Exposures: set shutter to "B", unlock release, push it in, and keep it depressed for the duration of the exposure. For exposures free from camera movement: use a cable release!

Long Time Exposures: set shutter to "B", depress release button slightly (without opening the shutter!) and lock it in this position (3a). Exposure: depress release completely (3b). Release safety guard to terminate the exposure (3c).

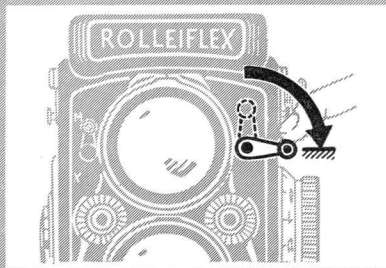

1

Self-Timer

With cocked self-timer the shutter opens approximately 10 seconds after it has been released. With the exception of B and 1/500 seconds all shutter speeds from 1 to 1/250th seconds may be used.

Operation of Self-Timer (when shutter is cocked):
cock self-timer lever until it stops (1), then release.

The shutter and self-timer may be left cocked even when the camera is laid away for short periods of time without weakening the power of the springs.

The Exposure

The correct exposure is dependent upon existing illumination (more exactly: subject brightness) and results from the selection of the proper diaphragm opening and shutter speed. Consequently the following relationship exists:

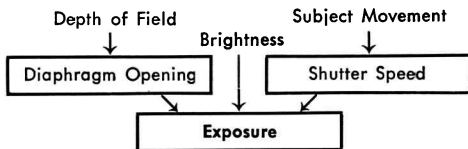

With the Rolleiflex, various settings of diaphragm openings and speeds may be combined as required for normal picture-taking. Only under unfavorable shooting conditions are these possibilities limited, so that a compromise solution is sometimes necessary. Nevertheless the following must be kept in mind: under-exposure results in hopelessly lost shadow detail, whereas over-exposure may be compensated for to a great extent by proper processing.

A golden rule for safe exposure:

Always expose for the **shadows**, rather a bit more than too little!

The Exposure Table

The table on the back of the camera is based on the speeds of the two most commonly used types of film: the upper scale is used with films rated at 100 ASA (21/10° DIN), and the lower scale is used with film rated at 50 ASA (18/10° DIN). Conversion of the table for use with other film speeds is possible, if it is remembered that half the ASA rating (or minus 3/10° DIN) means that double the exposure is required (see page 52).

For the two months immediately bracketing the summer months or if the sun is lower in the sky or if the sky is overcast, double the indicated exposure. If more than one of these conditions prevail, double the exposure for each factor.

Exposure in the wintertime around noon: with snow — use the normal values of the table, without snow — multiply exposure by 4.

The table, although not always exact, has nevertheless proved itself so good that serious exposure errors are generally avoided. In difficult cases or for greatest accuracy, it is advisable to use a photo-electric exposure meter.

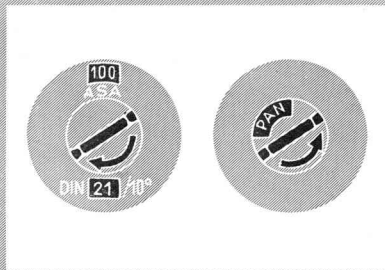

1

2

Film Reminder in Focusing Knob

In order to know with which film material the camera was last loaded two adjustable discs, located in the front part of the focusing knob, are rotated by means of a cam in the center: if turned to the **right (1)** it indicates the **speeds** 8 to 160 ASA (10/10° to 23/10° DIN), if turned to the left (2) it indicates the **film types** Ortho, Pan, Color daylight film ☉ and Color artificial light film ☾.

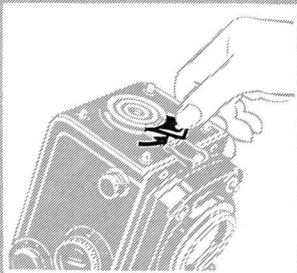

1

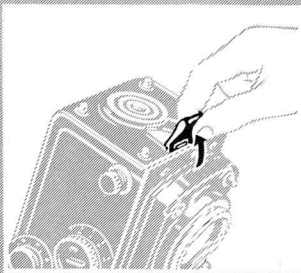

2



3

III. LOADING AND FILM TRANSPORT

The Rolleiflex is loaded with $2\frac{1}{4} \times 3\frac{1}{2}$ roll-film 120 or B II 8 (620 not usable) and delivers 12 exposures $2\frac{1}{4} \times 2\frac{1}{4}$. (See page 29.)

The loading of the camera is confined to a few simple operations: open the back — insert the full film spool — thread the film — close the back. From now on the film transport follows automatically through crank action.

Back

To Open: swing aside the back locking lever at the bottom of the camera (1), lift the clip (2), open back (3), using the clip as a handle.

To Close: with the flat of the hand push the back closed, fold down the clip and return locking lever to full forward position.

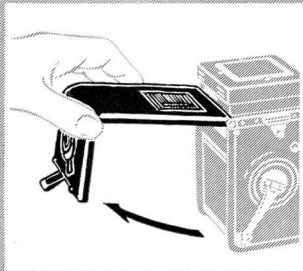

4

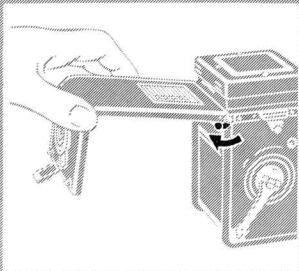

5

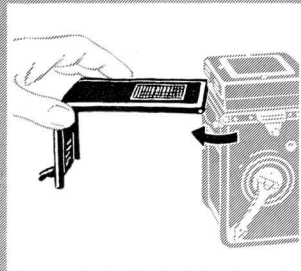

6

The back is generally removed only when replaced by the plate adapter.

To Remove: open back fully (4) and swing the locking lever on the right side back hinge (crank side) in the same direction until it stops (5). Slip back out of the opened hinge (6).

To Attach: insert detached back first into the left and then into the right hinge (with locking lever in the upper position).

Protect the open camera against prevailing dust and dirt and clean it occasionally with a soft camel's hair brush!

Never change film in direct sunlight, utilize at least your own body's shadow!

Note: for the Rolleiflex the following adapter accessories are also available: Rolleikin 2 C Attachment for 36 exposures 24×36 mm on 35 mm film, Plate Back Adapter for separate exposures $2\frac{1}{4} \times 2\frac{1}{4}$ " on plates or cut films $2\frac{1}{2} \times 3\frac{1}{2}$ ".

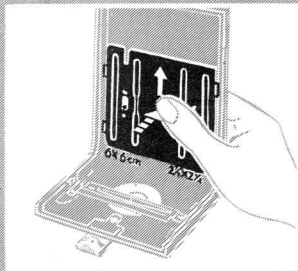

1

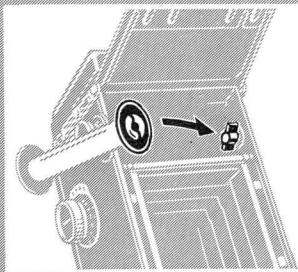

2

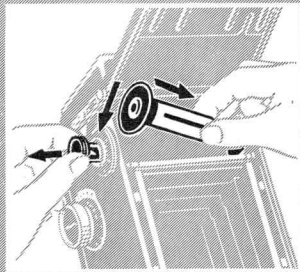

3

Film Pressure Plate Must be Positioned Correctly!

When roll film is employed, the inscription $2\frac{1}{4} \times 2\frac{1}{4}$ " must be visible below the film pressure plate. When changing from 120 roll film to 35 mm film, or the reverse, an adjustment must be made according to the film type being used.

To adjust the film pressure plate (1): Press the plate against the back and push it up or down until it stops. When released it must spring forward completely into the normal plane!

Inserting the Film Spool

In the factory-new camera the empty spool (take-up spool) is already in position. After removal of the exposed film the just emptied spool becomes a take-up spool, and must be transferred to the upper spool-chamber. The end with the slot goes to the right engaging the winding key of the film transport mechanism (2).

Both spools are held on the left hand side by spool knobs. The bearing pins are withdrawn when changing spools by pulling out the knobs.

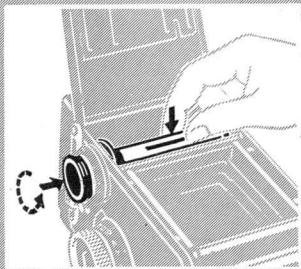

4

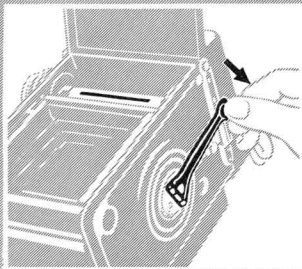

5

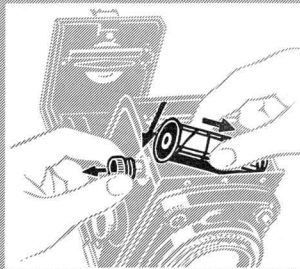

6

The upper knob (for the take-up spool) also serves as a Rolleikin counter knob (further details in the pamphlet "Rolleikin-Instructions").

To Insert the Empty Spool: first fit the spool over the winding key on the right (crank side) and pull out the guide knob (3). Push the spool down on the left applying slight pressure, so that the knob may snap back into place fully (4). It is then necessary to turn the crank until the long slot in the empty spool comes uppermost (5).

Note: when using the adapter the empty 120 (or B 2) spool is removed from the camera. However, it must be handily retained especially on trips, since otherwise a new roll-film cannot be loaded into the camera.

To Insert a Full Film Spool: in the same way as applies to the take-up spool (6). The pointed end of the backing paper must point in the direction of the take-up-spool chamber, so that the colored side of the backing paper remains on the outside.

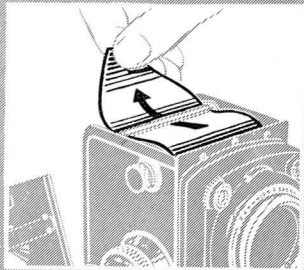

1

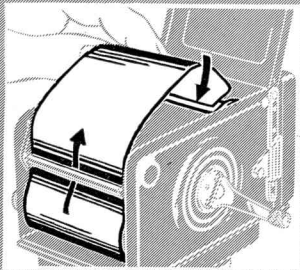

2

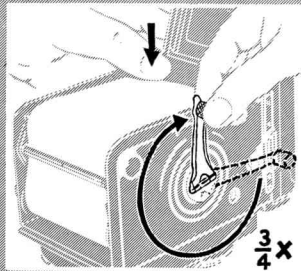

3

Threading the Film (Paper Leader)

After inserting the new film-spool tear the tape seal open and remove it.

1. Thread the beginning of the backing paper **through the rollers** of the film feeler mechanism (important!) and draw it up to the take-up-spool, colored and printed side outwards (1).

2. Push the paper leader through the long slot of the take-up-spool as far as it goes (2).

3. Tighten the backing paper by one spool turn (= approximately $\frac{3}{4}$ crank turn), making sure that the paper is wound up properly on the take-up spool (3). Close back (with the film pressure plate adjusted according to instructions!).

Film Transport

The correct positioning of the film according to the first and following numbers of the exposure counter is accomplished exclusively by the crank. The correct operation of this is governed by stops:

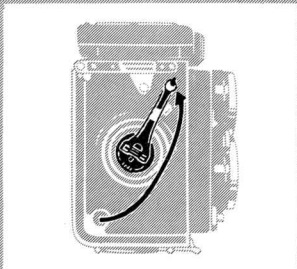

4

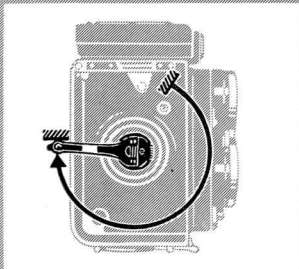

5

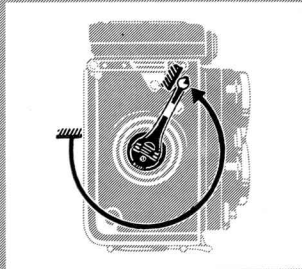

6

Swing out crank (4),
turn it until it stops with one continuous
swing (5) and then back again until the next
stop (6)!

It is now locked, until the automatically cocked shutter
is released. The simple rule then reads:

If the crank can be turned, it must be
turned — once in each direction until it stops,
until it locks!

When advancing the film to exposure No. 1 some 4
to 5 complete crank turns are required. During
the last turn a slight resistance of the mechanism
must be overcome as the counter moves from 0 to 1.
If it should happen that the crank reaches starting
position when it stops, reverse direction one full
turn, so that it locks!

During continued film transport the amount of crank
travel decreases gradually to about a half turn.

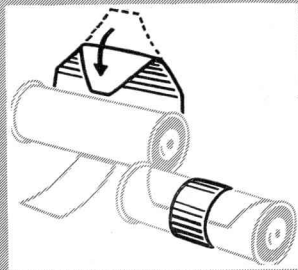
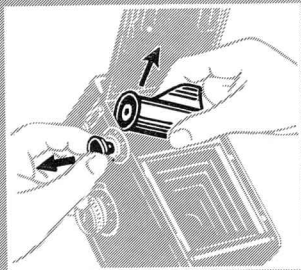
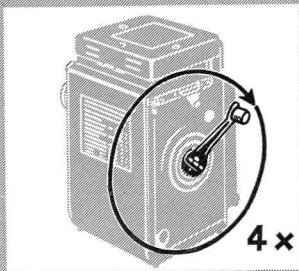

When making exposures in rapid succession it is unnecessary to fold down the crank each time. It remains locked in its starting position, ready for the next film advance, with a slight pressure of the thumb keeping it against its stop.

If longer intervals obtain between exposures the question could arise: has the film already been advanced and the shutter cocked? The crank gives the answer immediately:

Only if locked is it "ready to shoot"!

To Remove the Film

After the 12th and last exposure four complete crank turns are enough to wind off the rest of the backing paper (1).

To Remove: open the back in the shade, pull out upper spool knob and remove the film from the same side (2). Fold under a good portion of the backing paper (for easier opening when developing) and seal (3). Put the exposed film back into the light-proof protective cover of the original package!

IV. FLASHLIGHT TECHNIQUE

In modern flashlight technique the camera shutter takes over the task of firing the bulb electrically at the right moment. In this way instantaneous flash exposures are possible with a hand-held camera.

The Synchro-Compur shutter in the Rolleiflex is, for this purpose, equipped with electrical contacts. The contact may be adjusted to the required delay of the flash lamps by means of the Synchro-lever:

the **X-contact** presents the simplest type of contact. It is required for zero-delay electronic flash units (without relay) and a few flash lamps.

The **M-contact** means full synchronization. It works with most flash lamps and the electrically fired flash powder (capsule flash). The most important advantage of the M-contact: with certain flash lamps it may be employed at the shorter shutter speeds even including 1/500th sec. Due to the full synchronization the shutter is always open when the flash emitted by the lamp reaches its peak intensity.

Thus all types of instantaneous flash exposures are possible with the Rolleiflex.

The selection of flash lamp-type depends on the light output required by the subject. Many makes are available in three groups (normal, medium and high light output). The selection is dependent on the taking conditions, especially as to whether a room of shallow or great depth is to be illuminated.



Selection of M-X lever position, applicable speed range and exposures can be learned from the instructions of the different flash light products. For the best known makes the table on page 36 contains the necessary information and the permissible shutter speeds.

Connecting Flash Unit: push flash cord plug into the socket on the camera.

To Remove Flash Cord: move locking lever up or down and pull out the flash cord plug.

When setting contacts X or M:
Swing Synchro-lever a full 180° until it stops!

Flash contact and permissible shutter speeds

FLASH LIGHT SOURCE		Contact	Shutter Speeds:	
Make	Type		Fastest Recommended	Slowest Recommended
I. Electronic Flash		X	1/500	1/250 1
Without Relay(1/5000)				
General Electric	SM (1/200)			
Westinghouse		X	1/100	1/100 1
Sylvania	SF (1/200)			
	FO (1/100)	X	1/50	1/50 1
Osram	F1, F2 (1/50)			
	XP, XO (1/200)	X	1/25	1/25 1
II. Flash Lamps		M	1/500	1/25 1
Osram	S2			
	S0, S1			
Philips (Mazda)	PF3N, PF14, PF25, PF56			
General Electric	No. 5, 11, 22	M	1/500	1/50 1
Westinghouse				
	Press 25, 40, Nr. 0, Bantam 8			
Sylvania	No. 2	M	1/100	1/50 1
Philips (Mazda)	PF 110			
General Electric	No. 50	M	1/50	1/25 1
Westinghouse				
Sylvania	No. 3			
General Electric	No. 6, 31			
Westinghouse		M	1/250	1/25 1
Sylvania	FP 26, No. 2A			
III. Capsule Flash		M	1/100	1/25 1
	Average			

Explanation of the Table

The "Contact" column indicates the correct setting of the M-X lever for each lamp type.

The "Shutter Speeds" column shows the permissible speed range:

Center: the recommended shutter speed includes practically the entire light output of the flash lamp. This assures the maximum illumination as well as the smallest diaphragm (for greater depth of field). The following applies as a general rule:

Use the standard recommended speed together with the correct setting of the M-X lever for the lamp in use.

Left: the fastest speed indicates the limit to which the shutter may be set. For lively action or sports subjects, the faster speeds are employed.

Right: the exposure time may be increased to the slowest speed (1 second or even time exposures), if, in addition to the flash, it is desired to make use of existing light. In such cases the total amount

of light from all sources must be considered in choosing the diaphragm opening.

The Effective Exposure Time (as indicated in the table by means of colored ink) is not in each case identical to the shutter speed, but depends on the portion of the flash lamp light output utilized:

With X-Contact the duration of the flash itself is actually shorter than any of the permissible shutter speeds. Therefore, the duration of the flash (figure shown in parenthesis) is the effective appropriate exposure time and the diaphragm opening must be the same regardless of the shutter speed selected.

With M-Contact the shutter speeds, from "fastest" to "recommended" fall within the duration of the flash: they therefore represent the actual exposure time and if the shutter speed is increased, the diaphragm must be opened accordingly. Only when slower shutter speeds are employed is the fully utilized light output equal to the actual exposure time, and this is the same as the recommended speed.

The illustration should make the utilization of the available flash light still more obvious: the white symbols represent the flash, and their size, the utilized light at the shutter speed employed.

How the Flash Contacts Work

The information given thus far is entirely sufficient for normal purposes and is adequately supplemented by the exposure tables usually furnished by the various flash lamp manufacturers.

The photographer who is familiar with and habitually makes use of flash lamp graphs should know something about the method of operation of both flash contacts.

X-Contact (zero-delay): contact is made shortly before the shutter blades reach full opening. Application: for lamps with short firing time (up to 5 milliseconds) and short flash duration.

M-Contact (full synchronization): contact is made approximately 16.5 milliseconds before the shutter blades are fully opened. Application: for flash lamps with long firing time (average firing delay 16.5 milliseconds) and long light duration.

For safety reasons one pole of the contact is grounded to the camera body (isolation-test: 700 volts). All commercially available flash guns and electronic flash units may be used. Current-carrying capacity of the contact when several flash lamps are connected simultaneously: 10 ampères at 24 volts for a period up to a maximum of 1/10th sec.

Tips on Flashlight Photography

1. Use fresh batteries. Condenser or capacitor flash-guns are more consistent since lamp ignition is somewhat less dependent on battery power (Rolleiflash).
2. Be sure that the contacts of the battery and lamp sockets are clean. Handle flash cable with care, avoid kinking, otherwise there will be danger of short-circuit and premature flash ignition. — Note: the contact must not be connected to house current!
3. Blue flash lamps, like electronic flash, simulate daylight and are intended for use with daylight color film.
4. The power of flash illumination decreases according to the square of the distance: i. e., an object six feet away receives only one-fourth the light as an object at three feet. Distance from flash to subject must therefore be carefully considered in selecting diaphragm opening. Lamp manufacturers supply easy to use guide numbers which are divided by the distance in feet to obtain the required diaphragm opening.
5. Flash as main light source: do not take weak room illumination into account, expose strictly according to flash output.
6. Flash as fill-in light: useful in brightening shadows whether due to insufficient illumination or to the

fact that the picture is being taken "against-the-light", in full sunlight. The fill-in light must be kept at a lower intensity level than the main source of illumination, otherwise the strong flash will give an unnatural effect, not at all like daylight. Too strong a flash might even cause an apparent underexposure of the sky or the area not reached by the light. Electronic flash units are particularly well suited for use as fill-in lights when shooting color sports pictures. Use smaller lamps or keep them at greater distance.

7. Reducing the blinding effect of flash: the flash from regular flash lamps may be made "invisible" by dip coloring the bulb. Color solution No. 1 (200 cc warm water + 10 cc glycerin + 4 grams methylviolet) is used for panchromatic films. Open diaphragm 2 stops. Tone values are not changed in the picture. Additional dipping in color solution No. 2 (200 cc water + 10 cc glycerin + 4 grams tartrazin) will do for infra-red film. Open diaphragm 3 stops.

8. Developing: normal development of electronic flash pictures tends to produce insufficient contrast due to the very short time that the light is allowed to act on the film. The remedy is to develop longer or to use special "hard" developers.



Rolleiflash



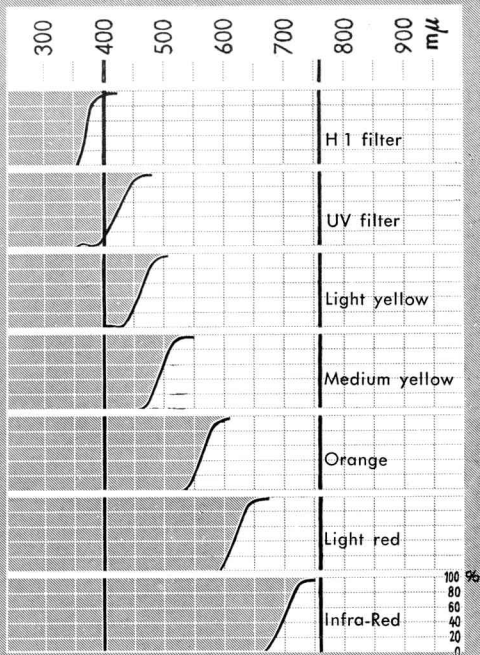

V. TIPS ON PICTURE-TAKING

Landscapes

Focusing Rule: distant views with foreground. Focus on part of subject nearest to camera and then set focusing knob to twice the distance — use diaphragm setting indicated opposite ∞ . Example: close point is 15 ft, set focus to 30 ft, diaphragm opening indicated opposite is f: 11. Depth of field is from 15 ft to ∞ .

Filters: important for separating tones, which would otherwise be similarly rendered by the black and white film, or for influencing the mood of the picture.

1. Blue Sky with Clouds: yellow filters darken blue skies and thus improve the reproduction of clouds. The deeper the color of the filter, the stronger and more dramatic the effect. Blue snow shadows are also rendered truer to tone. The green filter tones down the sky, brightens foliage and darkens the occasionally too lightly rendered reds (with pan film) such as sun-tanned flesh and red tile roofs. For filtering the sky but not the landscape: when pictures are taken with "back towards the sun" the Rolleipol filter darkens the blue sky only by eliminating the polarized light.

2. Haze and Mist: the blue filter, useful for pictorial effects, increases hazy effect. The orange or red cut through and improve the clarity of distant views. The blue filter reduces contrast, the red or orange increase brilliance. Maximum penetration of light haze is obtained with infra-red film and infra-red filter (700 $m\mu$). Barely visible mountain chains are reproduced clearly. An odd effect with this combination is that green leaves are rendered almost white. Filters are of no use at all in really bad weather when there is a good deal of moisture in the air.

3. Sea, Beach, Mountains: strong ultra-violet rays must be absorbed through use of UV filter. Results will otherwise be dull. The H 1 filter serves the same purpose for daylight-color film. Reduction of the bluish cast is quite marked.

Picture Composition Rules: distant views are generally better if foreground contains (for added depth impression) trees, people, animals, etc. Foliage is often used as a frame for the distant view. Focus should be sufficiently sharp in the foreground. Strong effects are created when deep shadows in the foreground are set against the lighter distance. Side lighting or even back lighting give the most impressive pictures.

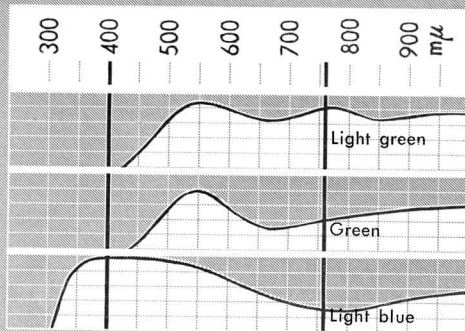

The filter curves show the absorption of the various Rolleiflex filters in the spectral ranges ultra-violet, visible spectrum blue to red (appr. 400—760 $m\mu$), and infra-red. This means: darker portion of the spectrogram = absorbed light; lighter portion = useful light. The light-transmission of the filter from the lowest point to the peak point of the curve thus increases from 0 to 100%. While the H 1 filter cuts out the short wave ultra-violet portion of the spectrum, the green filter absorbs a substantial portion of the long wave red and infra-red range.



Portraits

Large heads: do not work closer than 40 inches to avoid possible perspective distortion. If necessary, enlarge from a smaller section or use Rolleikin. Focus on the eyes. Use quiet, neutral colored backgrounds and do not stop down too much ($f: 5.6$) so as to keep backgrounds from intruding. If possible, move subject away from background. Out of doors, try using sky as only background. Open air portraits are best taken early or late in day when light is softer and not too blinding. Favor soft light, avoid deep shadows. In emergencies use reflectors or fill-in flash. Simple, proven artificial light procedure: lamp No. 1 next to camera somewhat above head level, lamp No. 2 on the side to lighten shadow, approximately $1/25$ th sec. For special effects, lamp No. 3 as overhead or back-light. Important: use lens hood and focusing extension hood for reducing extraneous light. Pan film, no filter. Moisten lips (high-lights!). To reduce sharpness and add "glamor": Rolleisoft (soft diffusion disc) 0 or 1 (stronger) over lens. Use larger diaphragm openings and backlight for sunny effects.



Children

Never use force, watch for interesting effects and expressions carefully. A clever assistant to divert children's attention from camera is often a valuable aid. Try close-up shots of children's expressions as they listen to favorite or exciting stories. Laughter, astonishment, pity and even an occasional yawn provide wonderful material for good shots or picture series. For close-up shots use same technique as for portraits. For children in motion, use snapshot technique outdoors and flash indoors. Low viewpoints and close-up effects are best.

Animals

Patience, quietness and familiarity with the animal and its peculiarities are great assets. Close-up pictures are most rewarding; use portrait technique. Make use of natural light effects such as back-lighting. Action pictures: use snapshot or sport technique (with flash, if needed). Rolleinars are often helpful with small animals. Zoo: animal portraits — avoid bars or netting. Hint: netting often becomes invisible when lens nearly touches wire. — Fish in aquarium: use side and overhead lighting in otherwise darkened room. A good trick is to limit movement of fish within sharp zone by means of vertical glass plate in tank.





Snapshots

Unexpected picture opportunities or rapidly changing subject distance make a simplified technique, based on depth of field zones, highly desirable. The following three settings have been found very effective:

1/100 sec.

Diaphragm opening f : 8

Short distances approx. 9 to 16 ft	Medium distances approx. 14 to 35 ft	Long distances approx. 18 to 80 ft
--	--	--

12 ft.

20 ft.

30 ft.

Shutter speeds and diaphragm openings do not often need changing in sunlight. Those suggested cover most contingencies. Thus instead of wasting time focusing when in a hurry, use one of the above settings. This snapshot technique is especially useful with the direct view finder. Variation of the values (see table page 21) makes this technique available for other depth of field zones. Example: diaphragm opening f : 11, focus at 30 ft, depth of field extends from 15 ft to ∞ for snapshots of scenes. Chief uses for this technique: groups in motion, street scenes, playing children, reportage, sports.

Sports

Sports pictures are generally most effective when the original rapid motion has been sufficiently "arrested" and the subject remains well defined. The fastest shutter speeds are essential, together with careful focusing. Sometimes pre-focusing on the spot where the action is to take place is possible. Do not overlook the possibilities of training sessions, since greater cooperation can often be had at such times. Snapshot technique is valuable for turf and ice shots and for any case when it would be difficult to guess exactly where to focus. Watch your shutter speeds and viewing angle. Shooting at right angle to the direction of the action requires a much faster speed than when the action is going in other directions (see table page 23). If the action is very fast or takes close to the camera, it is best to pan or follow with the camera. This results in a sharply rendered main object against a blurred background, thus increasing the impression of speed. There is often a fine moment for shooting when the action reaches a peak and stops momentarily, such as when a pole-vaulter "hits the top" before starting to come down again. With insufficient light or indoors use synchro-flash and 1/500th sec. The extremely short duration of electronic flash is highly desirable in some instances. Use the direct view finder; do not overlook the advantages of the Rolleikin with its telephoto effect, maximum use of film area and greater film capacity.

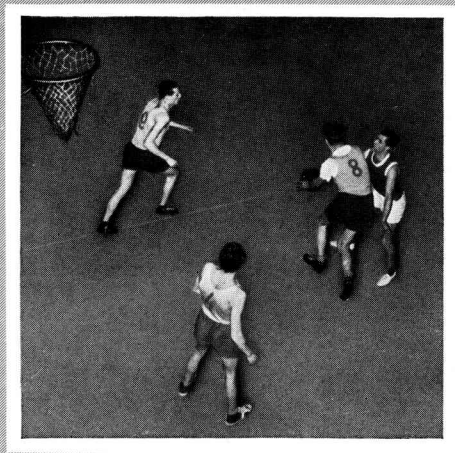



Theatre and Music-Hall

At longer distances only a section of the film is generally used hence this is a good field for using the Rolleikin. Do not depend on footlights but concentrate on spot-lighted performers or features. Exposures of $1/25$ th sec. are generally adequate under the strong lights with fast pan film. Color-dipped flash lamps (see page 39) permit flash exposures without disturbing spectators. After pre-setting focus you can use direct view finder most comfortably.

Night

Include direct light sources as symbols of the night in the picture. Only very strong, close lamps must be hidden behind natural foreground objects (building, tree, persons), otherwise over-exposure will result. Make use of effects: reflections in wet streets, light deflected by snow, early twilight with traces of brightness in the sky. Use fast pan film only. For time exposure: cover up lens when auto headlights cross the picture area, to avoid streaks. Use flash for snapshots at night, not for night shots.

Copying

Smaller originals are best copied with Rolleinar. See table page 55 for reproduction sizes. The camera should be set on a rigid, vibration free stand with the original parallel to the film plane. Use a small stop; f:11 recommended. Light evenly from both sides but avoid reflections. Glossy surfaces give less trouble if Rolleipol is used. Colored originals may require filter for better tone separation. Use contrasty ortho film (or even positive film with Rolleikin) for black and white originals. Spots on originals can be minimized by using a filter similar in color to spot with pan film. The Rolleikin is especially valuable for series or archive work. Single reproductions are economically taken with the plate back adapter. Reproductions from books are readable with ordinary magnifier directly from $2\frac{1}{4} \times 2\frac{1}{4}$ contact prints. Small objects (small machine parts, assembly pieces) may be handled similarly to copying. A spotlight can often be an additional aid in this case. Shadowless lighting effects are facilitated by placing object on a suspended glass plate. Reflections from fine glassware or other highly reflective objects can be reduced to a minimum, if the object is photographed by reflected light such as can be had inside an illuminated, white painted box.

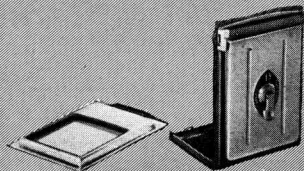
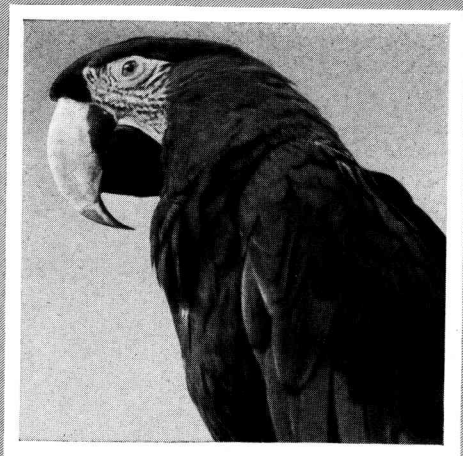

Shiny Surfaces

Eye-glasses, pictures, water surfaces, window glass and other brilliant reflecting surfaces often give disturbing reflections, not always avoidable by changing angle or illumination. A simple remedy in many cases is to use the polarizing filter Rolleipol. Reflected light is often polarized in one direction and this can be absorbed or reduced by proper orientation of the Rolleipol. This is done by merely turning it for best effect. It may sometimes be necessary to change camera position to obtain best angle. In artificial light a second pola-filter over the light gives full control at any angle. When the reflections are removed objects seen through the shiny glass or water surfaces become clearly evident. Torsion or strain tests of various materials are also possible with the help of the Rolleipol. Reflections from certain metal surfaces when the Rolleipol has little or no effect are best handled by photographing in diffused light or changing direction of illumination. Small, shiny metal parts can be held over burning magnesium to provide a white coat or greased and rubbed with graphite.

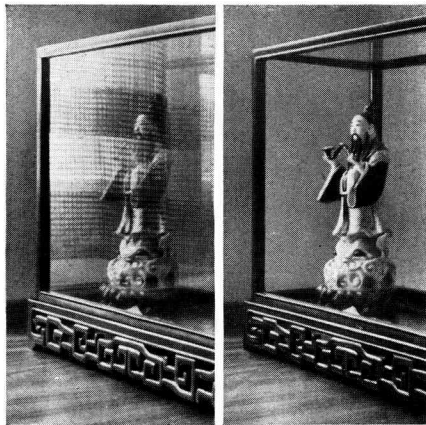

Rolleipol

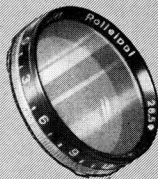

Plants

Flowers, blooms and grass are most effective in close-ups taken against the light. Use Rolleinar with fill-in light or reflectors. Stop down for needed depth of field and shoot in bright light with no wind. A semi-circular shaped cellophane shield is an effective guard against the ground breezes that destroy definition. Use filters to differentiate between equally bright colors. Keep in mind that a filter renders its own or similar colors lighter, whereas its complimentary color comes out darker.

Color Photography

Color films have little exposure latitude, so avoid strong light contrasts and use exposure meter. In doubtful cases make three exposures, varying diaphragm opening one half stop each side of what is considered normal. Correct color reproduction is possible only with correct matching of proper film types with illumination. Use compensating filters when needed according to manufacturer's instructions. Rolleipol-Filter: reduces glare from reflecting surfaces, also darkens the blue color of the sky (page 40) without affecting the color of the landscape. Select subjects with pleasing large color patches, not just an accumulation of loud colors. Overcast sky often renders pleasing pastel effect.





Multiple Exposures

The possibility of cocking the shutter without advancing the film (page 25) permits double or multiple exposures. Here are a few trick possibilities: multiple portrait images of the same person. Pictures of "doubles". Penetrations: technical apparatuses in closed and open presentation.

Action studies with flash: moving machine parts in various working positions. Publicity: photographs super-imposed on text, combination photos.

Tone separations: multiple exposures with different filters. Time and growth studies: phototropism, crystallisation. When pictures are taken from the same position: completely steady tripod, immovable position of camera. Cable release! Dark, unlighted background simplifies photographing objects which are placed side by side (reduces the danger of interfering background). To facilitate composition, fashion paper masks for ground glass.

Panorama Pictures

Special landscape pictures of distant views, which include a large portion of the horizon, are made possible with the panorama head when used in conjunction with a tripod. Either a few succeeding exposures can be made for normal panorama purposes or up to ten can be taken in order to cover the complete (360°) horizon. The separate pictures can be joined so that nothing is missing. When exposing: watch for any change in illumination and take pictures quickly if clouds are moving briskly.

Rolleigrid Lens

Covering the ground glass screen with this new field lens (Fresnel type) will considerably brighten the image at the edges. Critical focusing is easily accomplished through the clear center portion of the grid.

To install: place the Rolleigrid with the narrow front edge against the ground glass screen, let it slide forward under the retainer tab, then drop the rear end and fasten by means of the push-button at the rear of the focusing hood (p. 16). The condenser must be placed on the ground glass with the smooth side down. — **To remove:** turn the camera over, push the button, letting the Rolleigrid fall out of the hood.

Pictures Through the Microscope

When a microscope is focused by someone with normal eye-sight, the eye sees the image as if it were at infinity. Consequently, the Rollei, also focused at infinity, can simply take the place of the eye over the microscope in order to record the image on film.

Microscope and camera should be mounted on firm stands, without mechanical connections. Place the camera so that taking lens, focused at ∞ , is brought as close as possible to the ocular. Check optical axis carefully; film plane should be parallel to surface being photographed. For full coverage of $2\frac{1}{4} \times 2\frac{1}{4}$ use wide angle ocular, however, sufficient coverage for Rolleikin negative is to be had in any case. Framing through view finder is unnecessary. Do not stop down since this has no effect on exposure. Factors affecting exposure are illumination and transmission of the objective, to be ascertained through tests. Apochromatic micro-lenses are best, particularly with color film. In shooting black and white with these lenses, use ortho material and green filter. Generally interesting are micro-pictures of crystallized chemicals through Rolleipol filter in conjunction with another pola-filter over microscope condenser.

Care of the Rolleiflex

A precision camera demands care in handling. Protect it against moisture, dust, sand, strong sunshine, hard blows or falls. First safeguard: the ever ready case. Second safeguard (when not in use while traveling): a rubber bag to guard against water, sand or snow. Carry camera around neck to minimize transportation shocks. Keep all parts clear and clean lenses with a soft camel's hair brush or doeskin. Although the mechanism is not unduly sensitive to cold, some condensation may form on the lenses when the camera is brought in to a warm room from outside in cold weather. Do not wipe off — let moisture evaporate. In the tropics arrange to keep the camera, when not in use, in an air-tight container.

In Case of Damage to the Rolleiflex

The task of repairing major or minor damage is the special province of the expertly trained mechanic. Franke & Heidecke maintain their own special workshop in which all repairs are done with precision at nominal prices. Abroad, apply to photo dealers and factory representatives for full information.

Speed of photographic emulsions

(Comparison values approximated)

Relative exposure	DIN	Scheiner (Europe)	ASA (BS)	General Electric	Weston
8	7/10	18	4	4,5	3
7	8/10	19	5	—	4
5	9/10	20	6	7,5	5
4	10/10	21	8	9	6
3,3	11/10	22	10	12	8
2,7	12/10	23	12	15	10
2	13/10	24	16	18	12
1,7	14/10	25	20	24	16
1,3	15/10	26	25	30	20
1	16/10	27	32	36	24
0,8	17/10	28	40	48	32
0,67	18/10	29	50	60	40
0,5	19/10	30	64	75	50
0,4	20/10	31	80	100	64
0,33	21/10	32	100	120	80
0,25	22/10	—	125	150	100
0,2	23/10	—	160	200	125
0,17	24/10	—	200	250	160

The characteristics of the different rating systems do not permit a direct mathematical conversion. However, the approximate comparison values of the table offer sufficient information for most practical purposes.

The Practical Accessories for the Rolleiflex 2.8 C

Code:		Code:	
Berce	Ever-Ready Case for Rolleiflex 2.8 C	Koece	Leather Case containing: 1 Lens Hood, 2 Sets of Rolleinar Lenses and your choice of 5 Filters
Ceobe	Lens-Hood	Celee	Leather Case (without contents)
Ceihe	Rollei Yellow Filter, light	Focom	Complete Plate Adapter Equipment comprising: 1 Plate Adapter, 3 Slides, 1 Focusing Screen Slide, 1 Leather Case for 2 Slides
Ceimi	Rollei Yellow Filter, medium	Foapt	Plate Adapter
Celin	Rollei Green Filter, light	Fosli	Slide
Ceeen	Rollei Green Filter	Fopla	Cut-Film Sheath
Cesky	Rollei UV Filter	Focas	Leather Case for 2 Slides
Ceora	Rollei Orange Filter	Fofoc	Focusing Screen Slide
Ceubi	Rollei Red Filter, light	Rolce	Rolleikin 2 C
Cebla	Rollei Blue Filter, light	Foad	Panorama Head
Cehaz	Rollei H 1 Filter (UV Filter for Daylight Color Photography)	Fohod	Extension Hood
Cefir	Rollei Infra-Red Filter	Fogri	Rolleigrid Lens
Cetnu	Rolleisoft 0	Cesyn	Rolleiflash C Attachment
Ceton	Rolleisoft 1	Boxin	Boxin Case for Rolleiflash
Cetar	Rolleipol	Cekab	Connecting Cord for Flash Attachment 80 in.
Cepun	Rolleinar Lenses, set 1 (40-18½ in.)		
Ceodo	Rolleinar Lenses, set 2 (20-12½ in.)		

To avoid errors when ordering accessories please specify camera-number.

Full information on the use of Rollei accessories in the booklet "The Practical Accessories".

www.burda

Table of Rollei Filters

The filter factors indicate average values which, however, may be changed according to the particular type and make of film used and the light conditions.

Rollei Filter	Use	Filter Factor	
		Ortho	Pan
Light yellow	Landscapes, snow, clouds. Renders yellow and green lighter, blue darker.	3 x	2 x
Medium yellow		4 x	3 x
Light green	Landscapes, snow, clouds. Renders green lighter, red (complexion) and blue darker. For pan emulsions.	3 x	2 x
Green		4 x	3 x
Orange	Hazy distant views. Renders yellow-red lighter, blue darker, distant objects clearer.		3-7 x
Light red	Hazy distant views. Renders red lighter, blue-green darker. Gives stronger effects than Orange Filter.		4-10 x
Light blue	Artificial light. Renders red darker. For ultra-pan emulsions.	1.5x	1.5 x
UV	High altitudes above 6000 feet. Seascapes. Eliminates ultra-violet rays which reduce contrast.	1.5 x	1.5 x
Infra-Red	Special filter for infra-red emulsions. Transmits dark red above 700 m μ and infra-red.	*)	
H 1	UV-Filter, especially designed for long distance color photography. Absorbs ultra-violet rays, subdues predominance of blue and cuts aerial haze in distance shots.	No increase of exposure	

*) Exposure depends on the type of emulsion used and must be determined by tests

Focal Length and Focusing-Range with Rolleinar Lenses

Rolleinar Lenses	1	2
Focal Length	80 mm	76 mm
Focusing-Range (in inches)	$\infty - 35\frac{1}{2}$	$39\frac{1}{2} - 18\frac{1}{2}$
		$19\frac{3}{4} - 12\frac{1}{2}$

Field-Size and Scale of Reproduction

Focused Distance	$31\frac{1}{2}$ in.	$19\frac{3}{4}$ in.	13 in.
Field-Size (in inches)	$2\frac{1}{4} \times 2\frac{1}{4}$	22×22	$13\frac{3}{4} \times 13\frac{3}{4}$
	Rolleinar	$5\frac{1}{2} \times 7\frac{7}{8}$	$3\frac{1}{2} \times 5\frac{1}{8}$
Scale of Reproduction approx.	1:10	1:6.3	1:3.9

Depth of Field with Rolleinar Lenses

Rolleinar	1		2		f/Stop
Focused Distance (in inches)	$31\frac{1}{2}$	$23\frac{1}{2}$	$19\frac{3}{4}$	$15\frac{3}{4}$	
from to	$29\frac{1}{2}$ $33\frac{1}{2}$	$22\frac{1}{2}$ $24\frac{3}{4}$	$18\frac{7}{8}$ $20\frac{1}{2}$		5.6
	$28\frac{3}{4}$ $34\frac{1}{4}$	$22\frac{1}{4}$ $25\frac{1}{4}$	$18\frac{3}{4}$ $20\frac{7}{8}$	$15\frac{1}{8}$ $16\frac{1}{2}$	8
from to	28 $35\frac{3}{4}$	$21\frac{5}{8}$ 26	$18\frac{1}{8}$ $21\frac{1}{4}$	15 $16\frac{7}{8}$	11
	$26\frac{3}{4}$ $38\frac{1}{4}$	$20\frac{7}{8}$ $27\frac{1}{4}$	$17\frac{3}{4}$ 22	$14\frac{9}{8}$ $17\frac{1}{4}$	16
from to	$25\frac{1}{4}$ $41\frac{3}{4}$	20 $28\frac{3}{4}$	$16\frac{7}{8}$ $23\frac{1}{4}$	$14\frac{1}{4}$ $18\frac{1}{8}$	22

Taking-distance measured from lens panel to object. Permissible circle of confusion in this special case (due to the large image and less need for enlarging) = approx. $f/1000$. For increased sharpness further stopping down is required.